

C-PERF-M1
 OPEN AREA 2.3%
 SCALE: 1=1

CARRITEC
 Architectural Products
 2150 Boul Hymus
 Dorval (QC) H9P 1J7
 T: (514) 683-0179 F: (514) 683-9651

TOLERANCES:
 FRACTIONS DECIMALS ANGLES
 ±1/64 .XX 0.030 ±0.5
 .XXX ±0.015
 UNLESS OTHERWISE SPECIFIED
 DIMENSIONS ARE IN INCHES

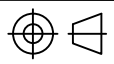

Material Finish Specifications:
 XXX THICK
 MATERIAL: XXXX
 FINISH: XXXX
 QTY: XXXX

SYSTEM XXXX
 DESC.
 Date: FEB-3-2016

Any copy hereof issued by CARRITEC must be kept confidential and used by the recipient only for the specific purpose for which it is issued in conjunction with materials supplied or purchased and listed hereon.

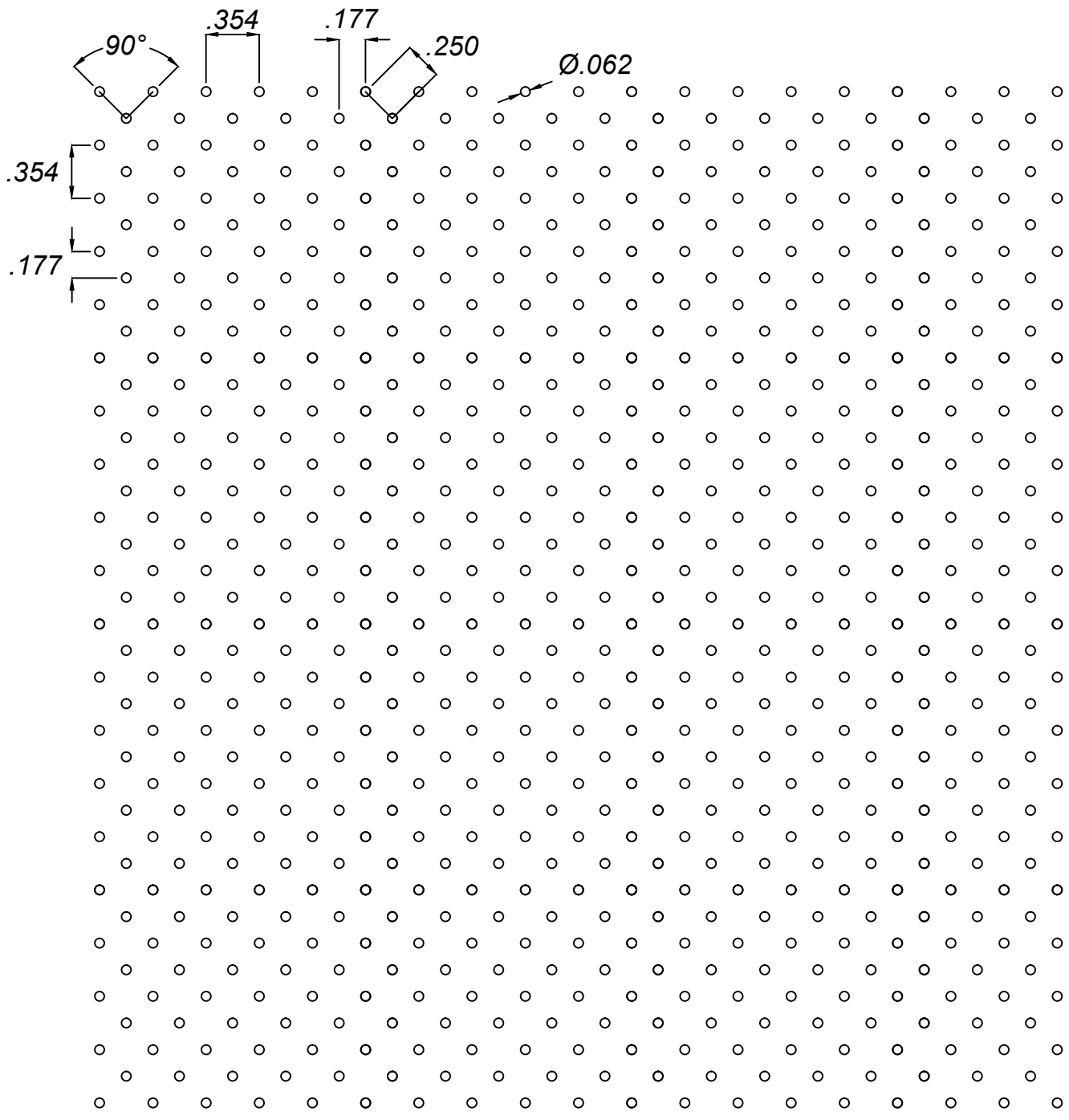

C-PERF-M2

OPEN AREA 4.6%

SCALE: 1=1



2150 Boul Hymus
Dorval (QC) H9P 1J7

T: (514) 683-0179 F: (514) 683-9651

TOLERANCES :

FRACTIONS	DECIMALS	ANGLES
±1/64	.XX 0.030	±0.5
UNLESS OTHERWISE SPECIFIED DIMENSIONS ARE IN INCHES		

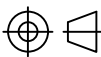

Material Finish Specifications:

XXX THICK
MATERIAL: XXXX
FINISH: XXXX
QTY: XXXX

SYSTEM XXXX

DESC.

Date: FEB-3-2016

PG
1/1

Any copy hereof issued by CARRITEC must be kept confidential and used by the recipient only for the specific purpose for which it is issued in conjunction with materials supplied or purchased and listed hereon.

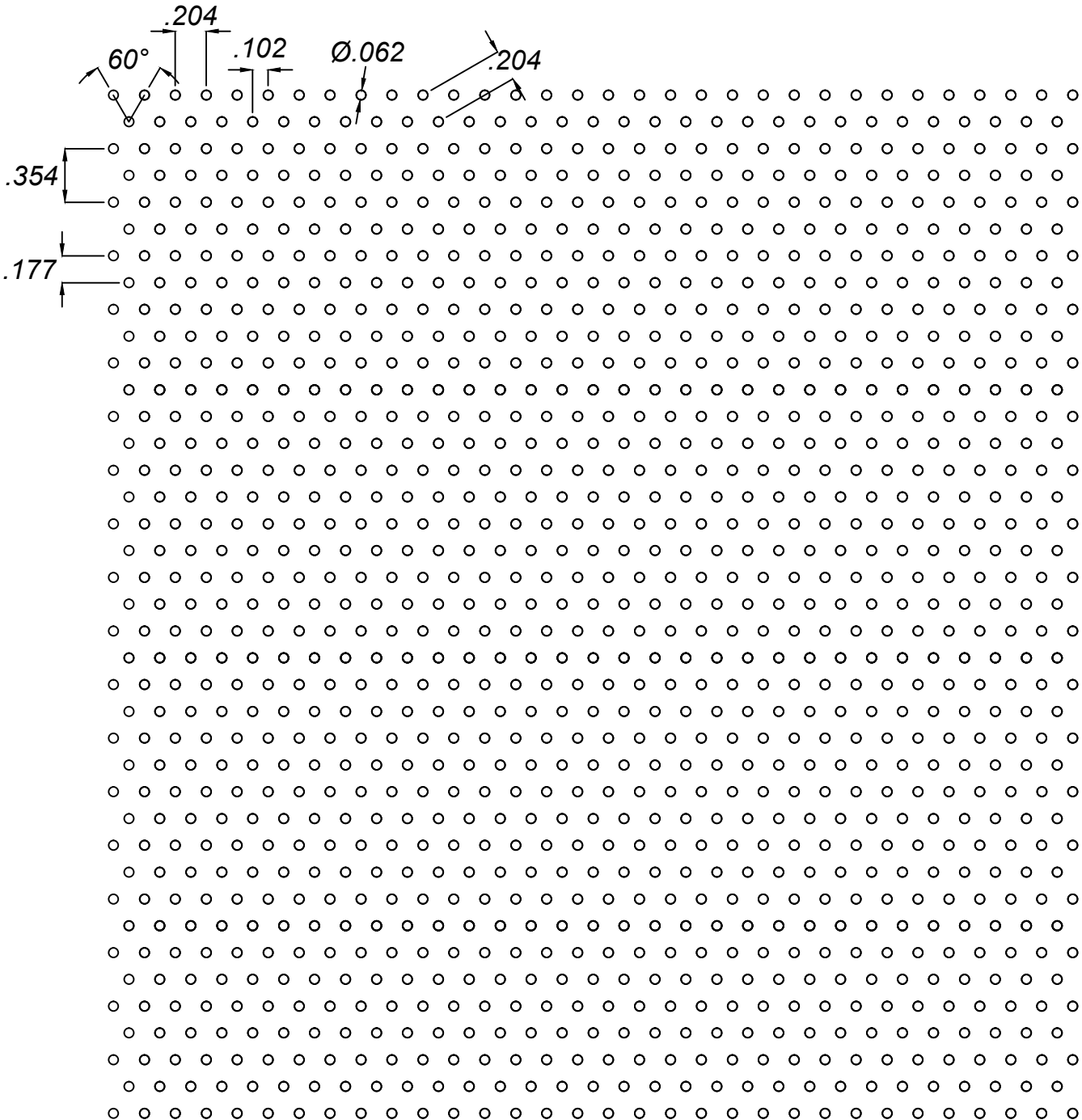

C-PERF-M3

OPEN AREA 8.4%

SCALE: 1=1

2150 Boul Hymus
Dorval (QC) H9P 1J7
T: (514) 683-0179 F: (514) 683-9651

TOLERANCES :

FRACTIONS	DECIMALS	ANGLES
±1/64	.XX 0.030	±0.5
	.XXX ±0.015	

UNLESS OTHERWISE SPECIFIED
DIMENSIONS ARE IN INCHES

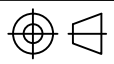

Material Finish Specifications:
 XXX THICK
 MATERIAL: XXXX
 FINISH: XXXX
 QTY: XXXX

SYSTEM	XXXX
DESC.	
Date:	FEB-3-2016
	PG 1/1

Any copy hereof issued by CARRITEC must be kept confidential and used by the recipient only for the specific purpose for which it is issued in conjunction with materials supplied or purchased and listed hereon.

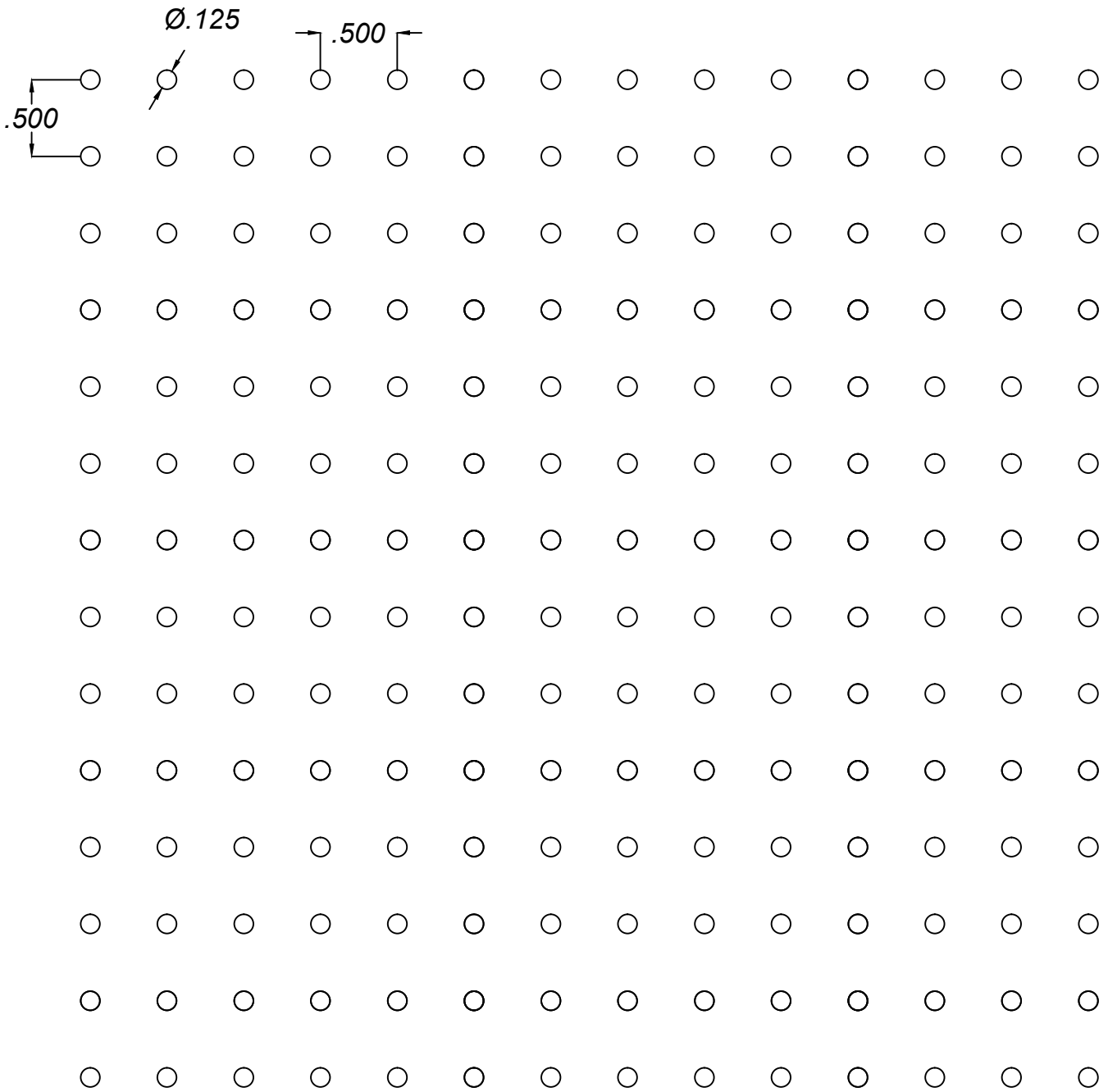

C-PERF-4
OPEN AREA 5%

SCALE: 1=1



2150 Boul Hymus
Dorval (QC) H9P 1J7

T: (514) 683-0179 F: (514) 683-9651

TOLERANCES :

FRACTIONS	DECIMALS	ANGLES
±1/64	.XX 0.030	±0.5
UNLESS OTHERWISE SPECIFIED		
DIMENSIONS ARE IN INCHES		

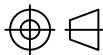

Material Finish Specifications:

XXX THICK
MATERIAL: XXXX
FINISH: XXXX
QTY: XXXX

SYSTEM XXXX

DESC.

Date: FEB-3-2016

PG
1/1

Any copy hereof issued by CARRITEC must be kept confidential and used by the recipient only for the specific purpose for which it is issued in conjunction with materials supplied or purchased and listed hereon.

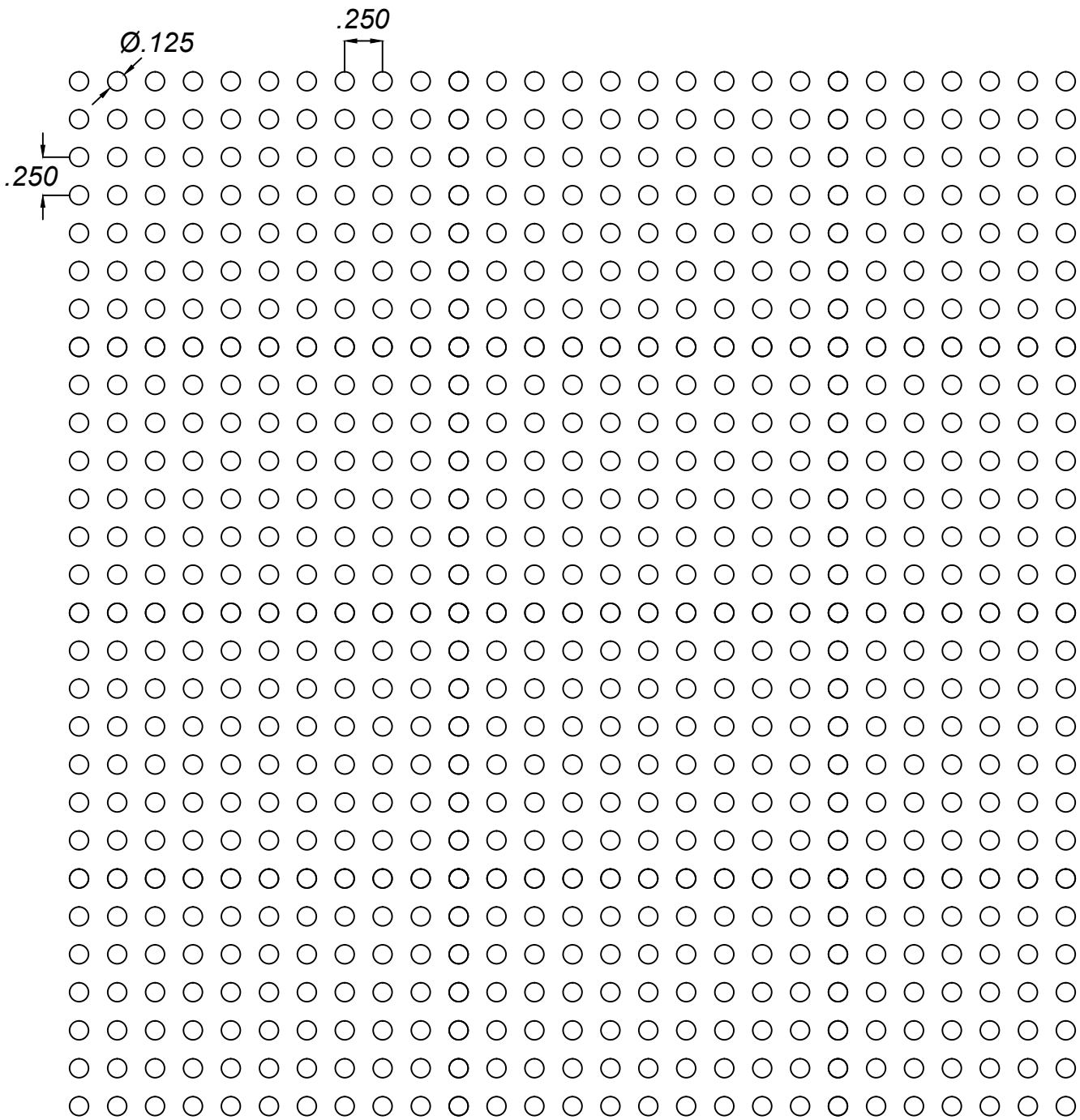

C-PERF-5
 OPEN AREA 20%

SCALE: 1=1



2150 Boul Hymus
 Dorval (QC) H9P 1J7
 T: (514) 683-0179 F: (514) 683-9651

TOLERANCES :

FRACTIONS	DECIMALS	ANGLES
±1/64	.XX 0.030	±0.5
	.XXX ±0.015	

UNLESS OTHERWISE SPECIFIED
 DIMENSIONS ARE IN INCHES

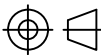

Material Finish Specifications:

XXX THICK
 MATERIAL: XXXX
 FINISH: XXXX
 QTY: XXXX

SYSTEM XXXX

DESC.

Date: FEB-3-2016

PG
 1/1

Any copy hereof issued by CARRITEC must be kept confidential and used by the recipient only for the specific purpose for which it is issued in conjunction with materials supplied or purchased and listed hereon.

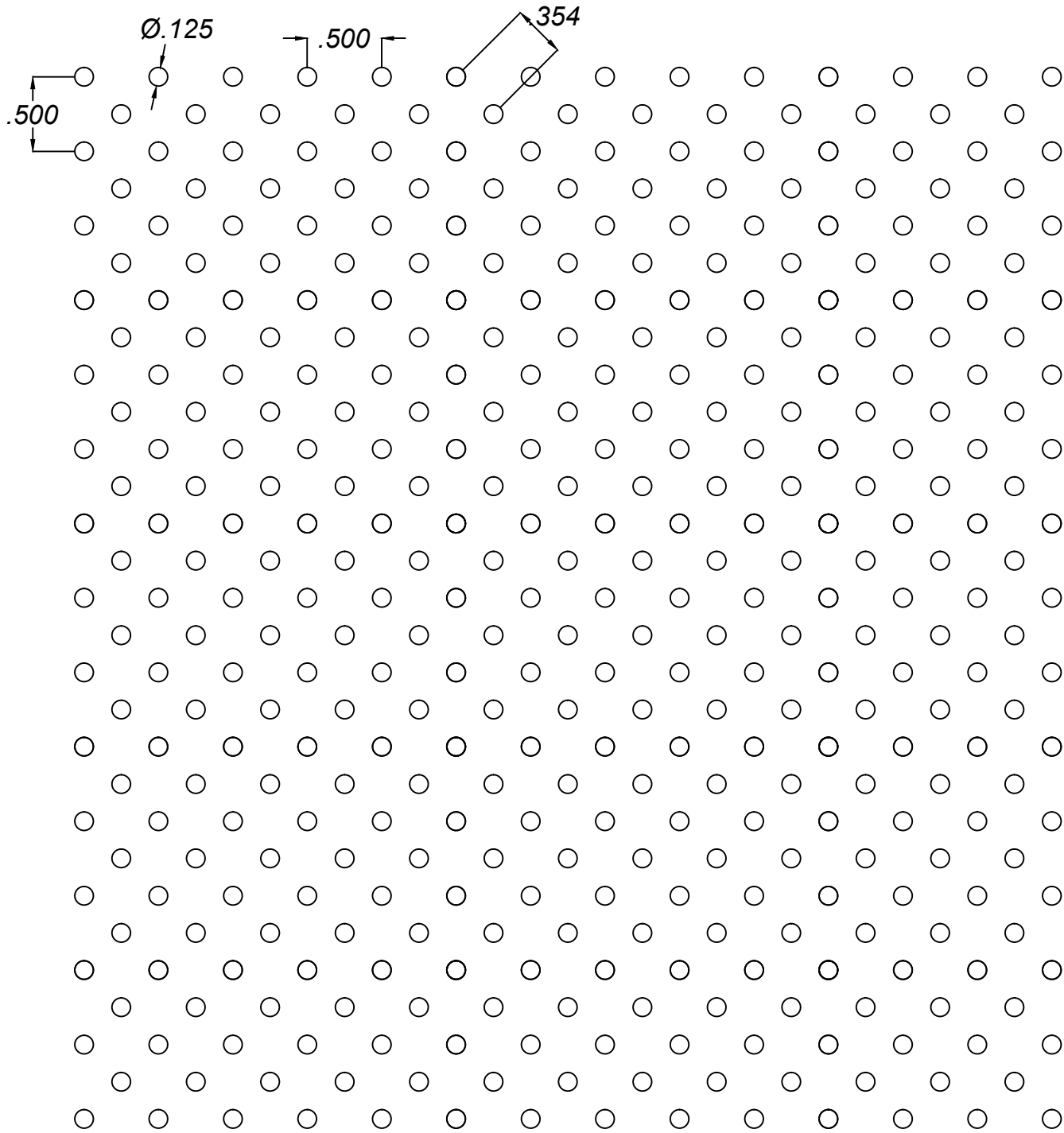

C-PERF-6

OPEN AREA 10%

SCALE: 1=1



2150 Boul Hymus
Dorval (QC) H9P 1J7

T: (514) 683-0179 F: (514) 683-9651

TOLERANCES :

FRACTIONS	DECIMALS	ANGLES
±1/64	.XX 0.030	±0.5
UNLESS OTHERWISE SPECIFIED		
DIMENSIONS ARE IN INCHES		

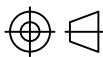

Material Finish Specifications:

XXX THICK
MATERIAL: XXXX
FINISH: XXXX
QTY: XXXX

SYSTEM XXXX

DESC.

Date: FEB-3-2016

PG
1/1

Any copy hereof issued by CARRITEC must be kept confidential and used by the recipient only for the specific purpose for which it is issued in conjunction with materials supplied or purchased and listed hereon.

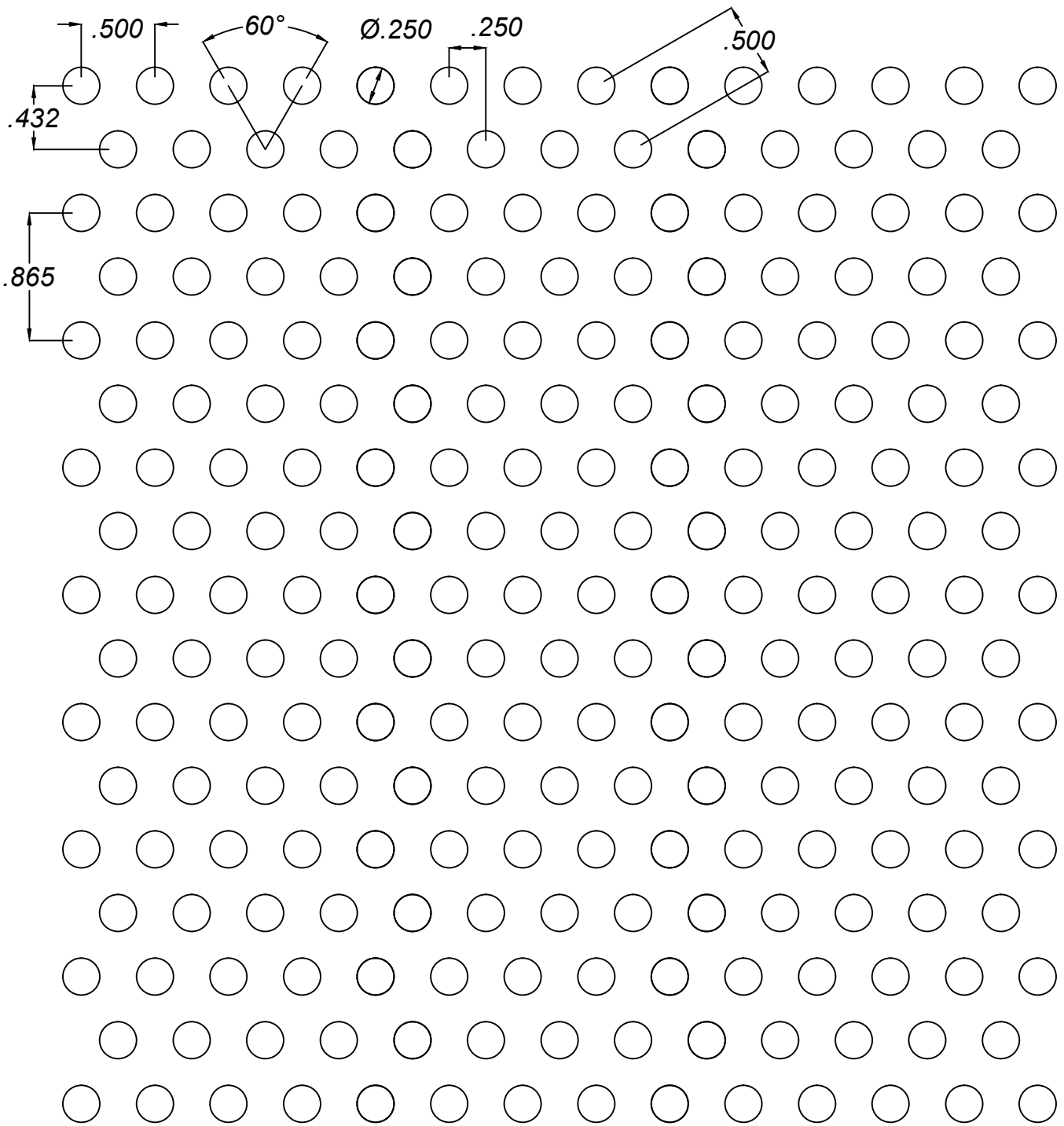

C-PERF-7
OPEN AREA 22.7%

SCALE: 1=1



2150 Boul Hymus
Dorval (QC) H9P 1J7

T: (514) 683-0179 F: (514) 683-9651

TOLERANCES :

FRACTIONS	DECIMALS	ANGLES
±1/64	.XX 0.030	±0.5
UNLESS OTHERWISE SPECIFIED		
DIMENSIONS ARE IN INCHES		

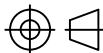

Material Finish Specifications:

XXX THICK
MATERIAL: XXXX
FINISH: XXXX
QTY: XXXX

SYSTEM XXXX

DESC.

Date: FEB-3-2016

PG
1/1

Any copy hereof issued by CARRITEC must be kept confidential and used by the recipient only for the specific purpose for which it is issued in conjunction with materials supplied or purchased and listed hereon.

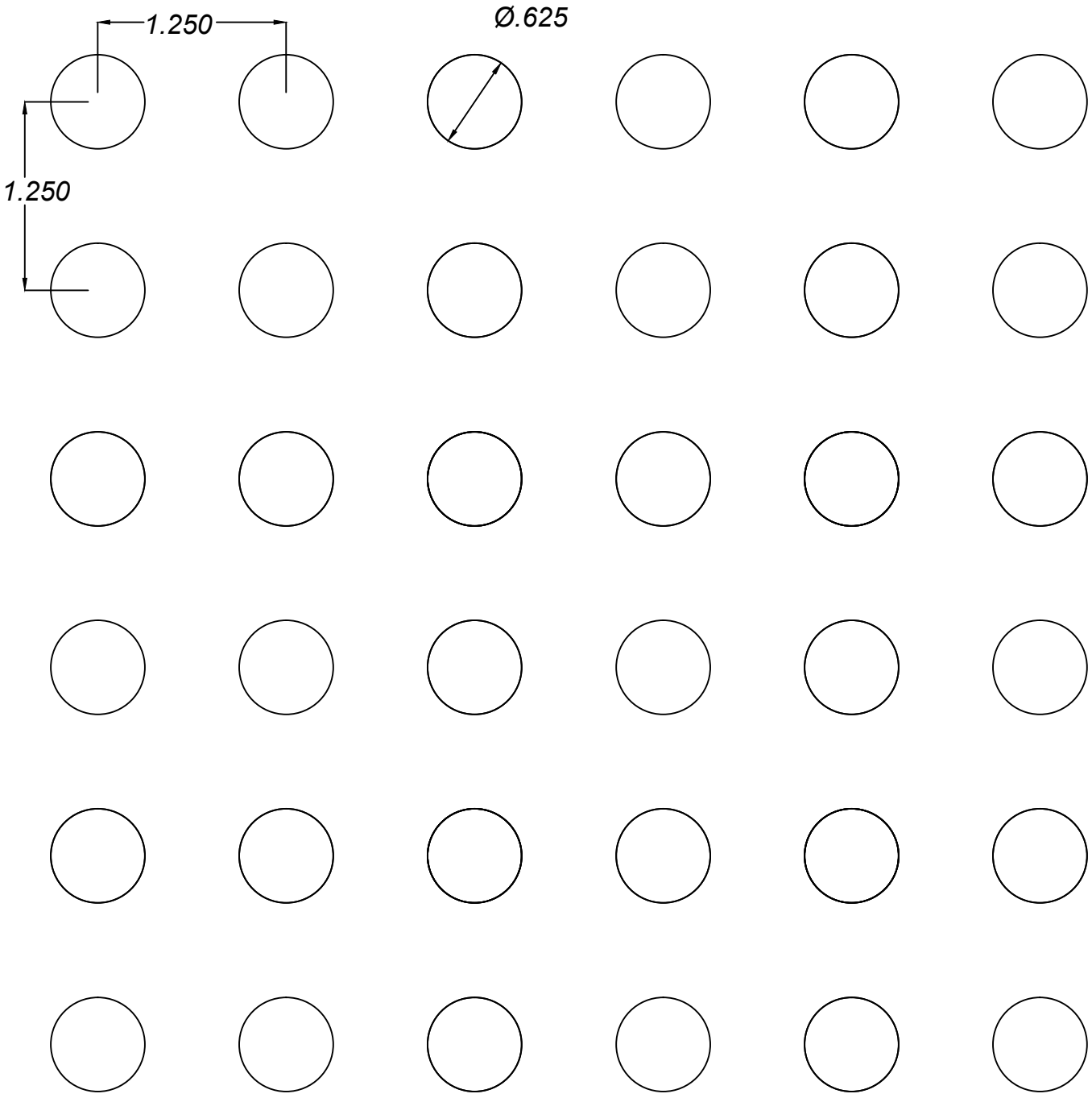

C-PERF-8
 OPEN AREA 19.6%

SCALE: 1=1



2150 Boul Hymus
 Dorval (QC) H9P 1J7
 T: (514) 683-0179 F: (514) 683-9651

TOLERANCES :		
FRACTIONS	DECIMALS	ANGLES
±1/64	.XX 0.030	±0.5
UNLESS OTHERWISE SPECIFIED		
DIMENSIONS ARE IN INCHES		

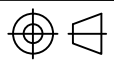

Material Finish Specifications:
 XXX THICK
 MATERIAL: XXXX
 FINISH: XXXX
 QTY: XXXX

SYSTEM	XXXX
DESC.	
Date:	FEB-3-2016
PG	1/1

Any copy hereof issued by CARRITEC must be kept confidential and used by the recipient only for the specific purpose for which it is issued in conjunction with materials supplied or purchased and listed hereon.

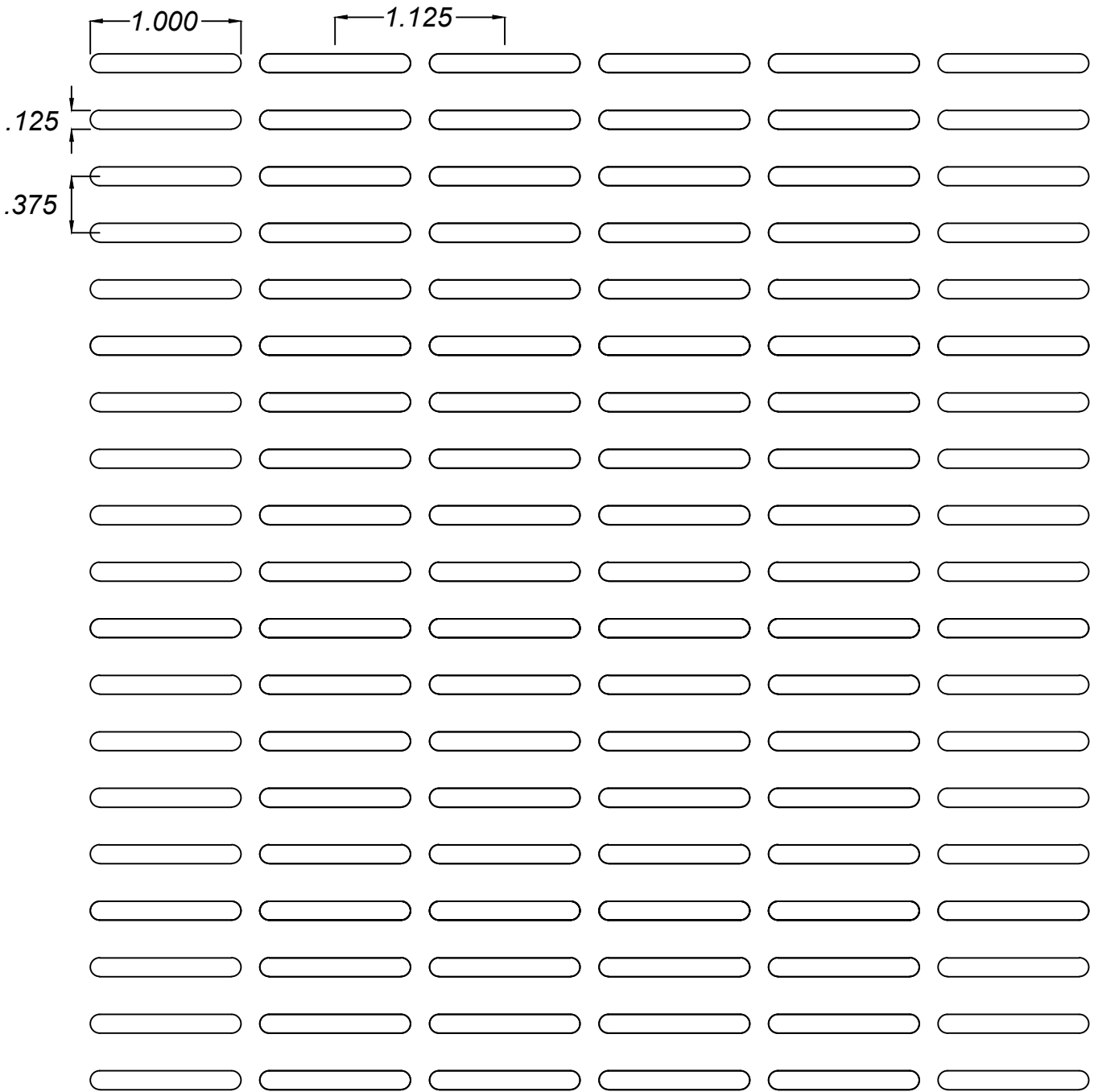

C-PERF-9
 OPEN AREA 28.8%

SCALE: 1=1



2150 Boul Hymus
 Dorval (QC) H9P 1J7

T: (514) 683-0179 F: (514) 683-9651

TOLERANCES :

FRACTIONS	DECIMALS	ANGLES
±1/64	.XX 0.030	±0.5
	.XXX ±0.015	
UNLESS OTHERWISE SPECIFIED		
DIMENSIONS ARE IN INCHES		

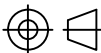

Material Finish Specifications:

XXX THICK
 MATERIAL: XXXX
 FINISH: XXXX
 QTY: XXXX

SYSTEM XXXX

DESC.

Date: FEB-3-2016

PG
 1/1

Any copy hereof issued by CARRITEC must be kept confidential and used by the recipient only for the specific purpose for which it is issued in conjunction with materials supplied or purchased and listed hereon.

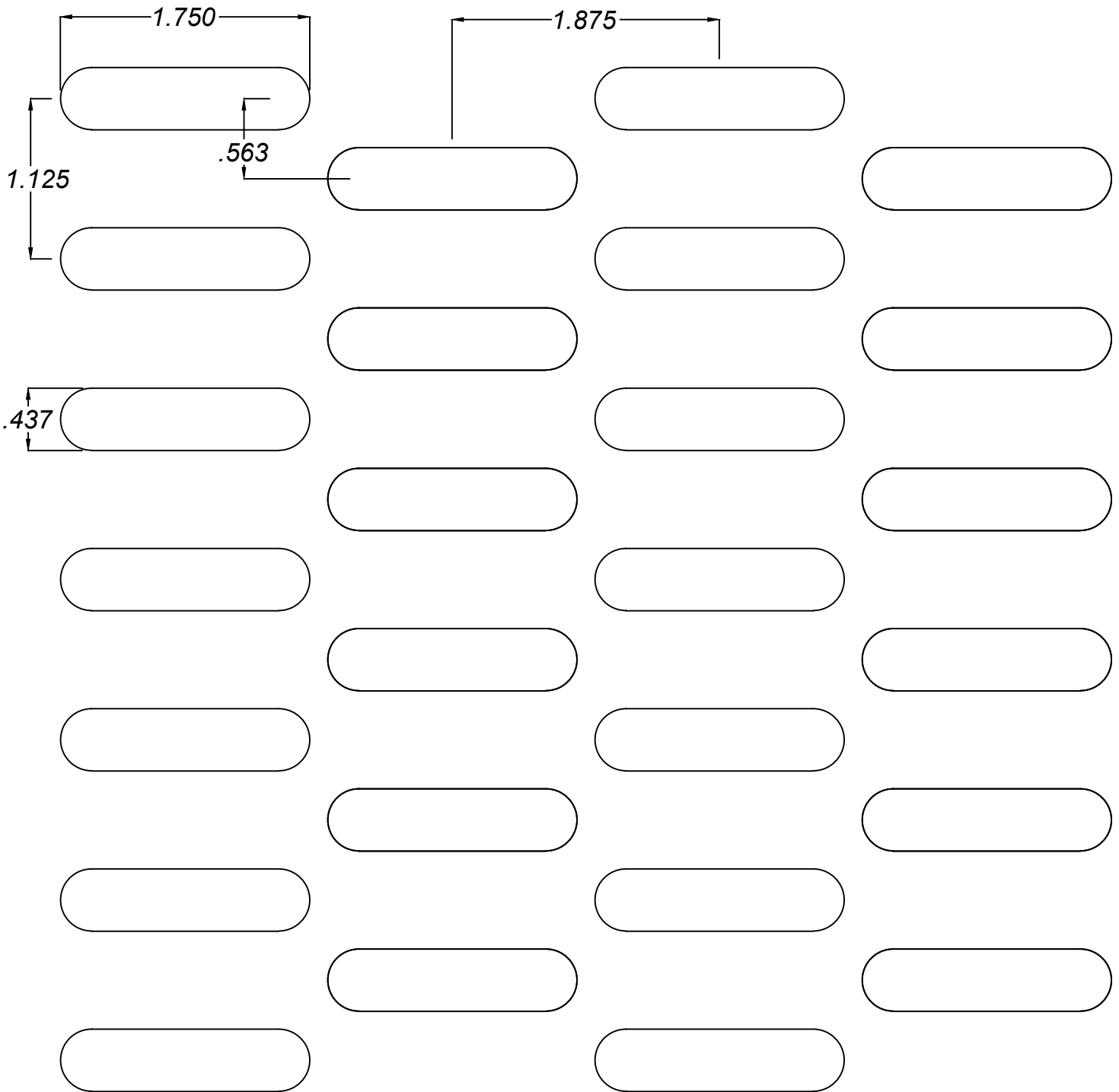

C-PERF-10

OPEN AREA 34.3%

SCALE: 1=1



2150 Boul Hymus
Dorval (QC) H9P 1J7

T: (514) 683-0179 F: (514) 683-9651

TOLERANCES :

FRACTIONS	DECIMALS	ANGLES
± 1/64	.XX 0.030	± 0.5
	.XXX ± 0.015	
UNLESS OTHERWISE SPECIFIED		
DIMENSIONS ARE IN INCHES		

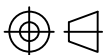

Material Finish Specifications:

XXX THICK
MATERIAL: XXXX
FINISH: XXXX
QTY: XXXX

SYSTEM XXXX

DESC.

Date: FEB-3-2016

PG
1/1

Any copy hereof issued by CARRITEC must be kept confidential and used by the recipient only for the specific purpose for which it is issued in conjunction with materials supplied or purchased and listed hereon.

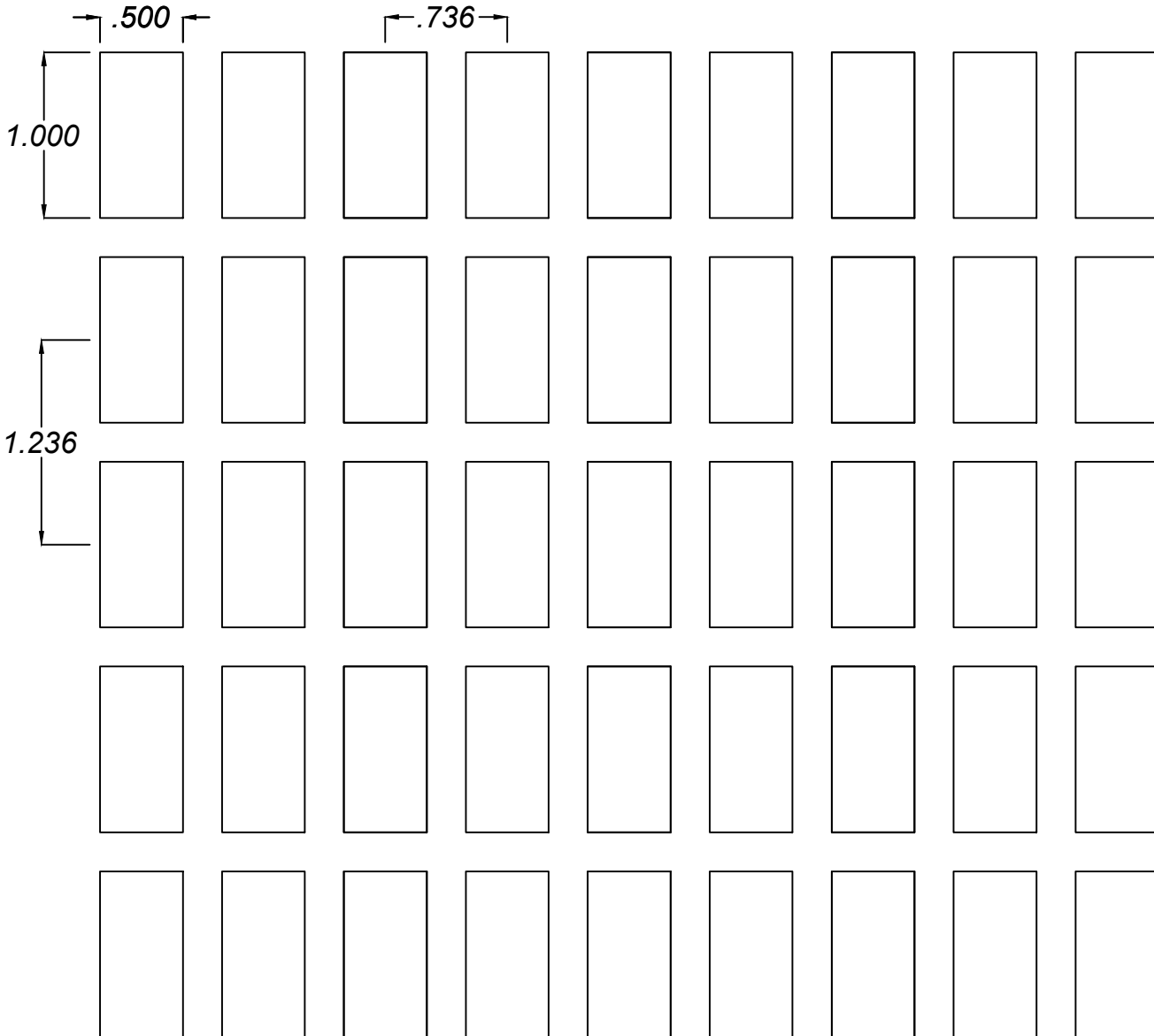

C-PERF-11

OPEN AREA 55%

SCALE: 1=1



2150 Boul Hymus
Dorval (QC) H9P 1J7
T: (514) 683-0179 F: (514) 683-9651

TOLERANCES :

FRACTIONS	DECIMALS	ANGLES
± 1/64	.XX 0.030	± 0.5
	.XXX ± 0.015	
UNLESS OTHERWISE SPECIFIED		
DIMENSIONS ARE IN INCHES		

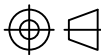

Material Finish Specifications:

XXX THICK
MATERIAL: XXXX
FINISH: XXXX
QTY: XXXX

SYSTEM XXXX

DESC.

Date: FEB-3-2016

PG
1/1

Any copy hereof issued by CARRITEC must be kept confidential and used by the recipient only for the specific purpose for which it is issued in conjunction with materials supplied or purchased and listed hereon.

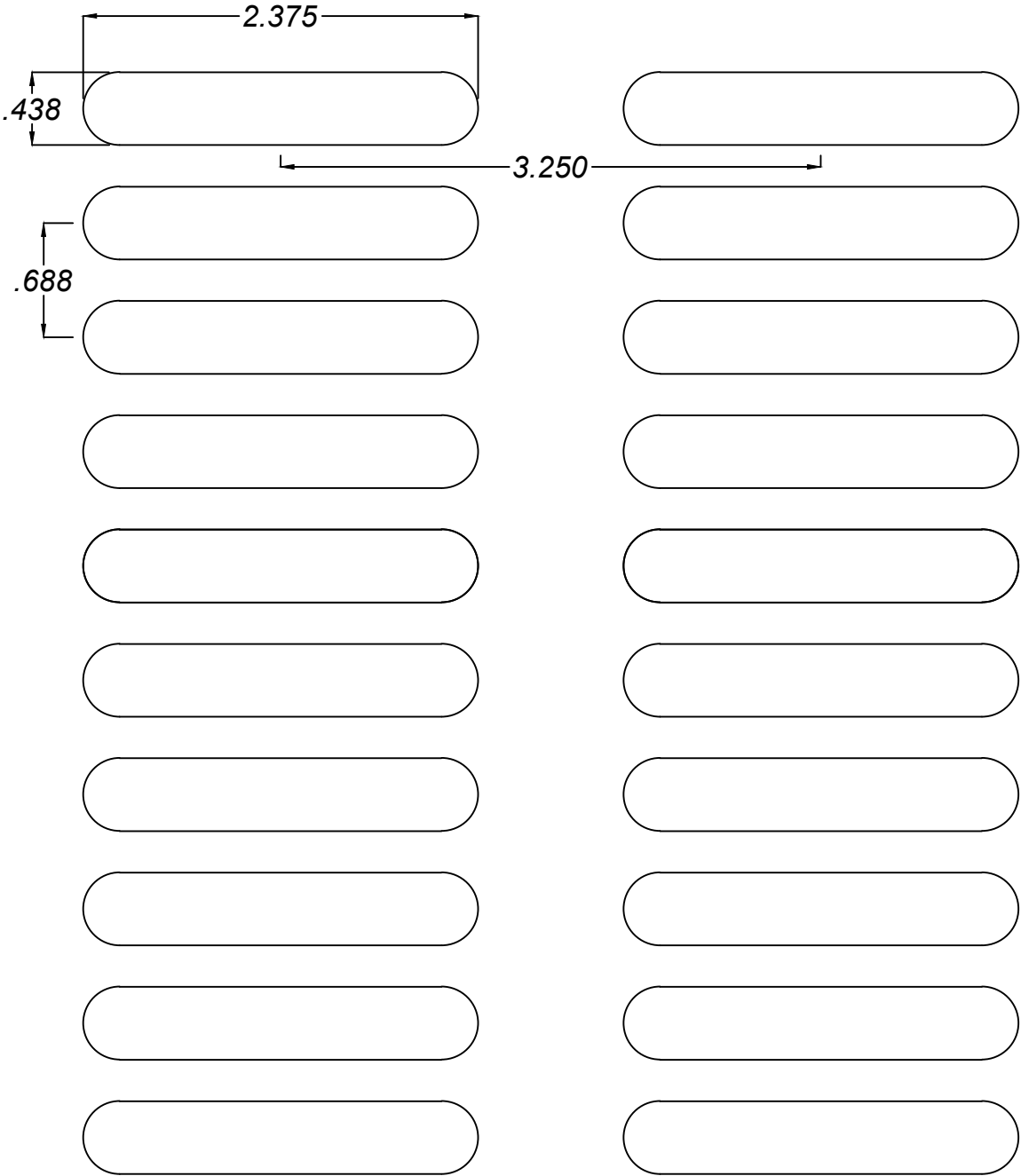

C-PERF-12

OPEN AREA 44.7%

SCALE: 1=1



2150 Boul Hymus
Dorval (QC) H9P 1J7
T: (514) 683-0179 F: (514) 683-9651

TOLERANCES :

FRACTIONS	DECIMALS	ANGLES
± 1/64	.XX ± 0.030	± 0.5
	.XXX ± 0.015	

UNLESS OTHERWISE SPECIFIED
DIMENSIONS ARE IN INCHES

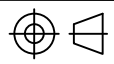

Material Finish Specifications:
XXX THICK
MATERIAL: XXXX
FINISH: XXXX
QTY: XXXX

SYSTEM XXXX

DESC.

Any copy hereof issued by CARRITEC must be kept confidential and used by the recipient only for the specific purpose for which it is issued in conjunction with materials supplied or purchased and listed hereon.

Date: FEB-3-2016 PG 1/1

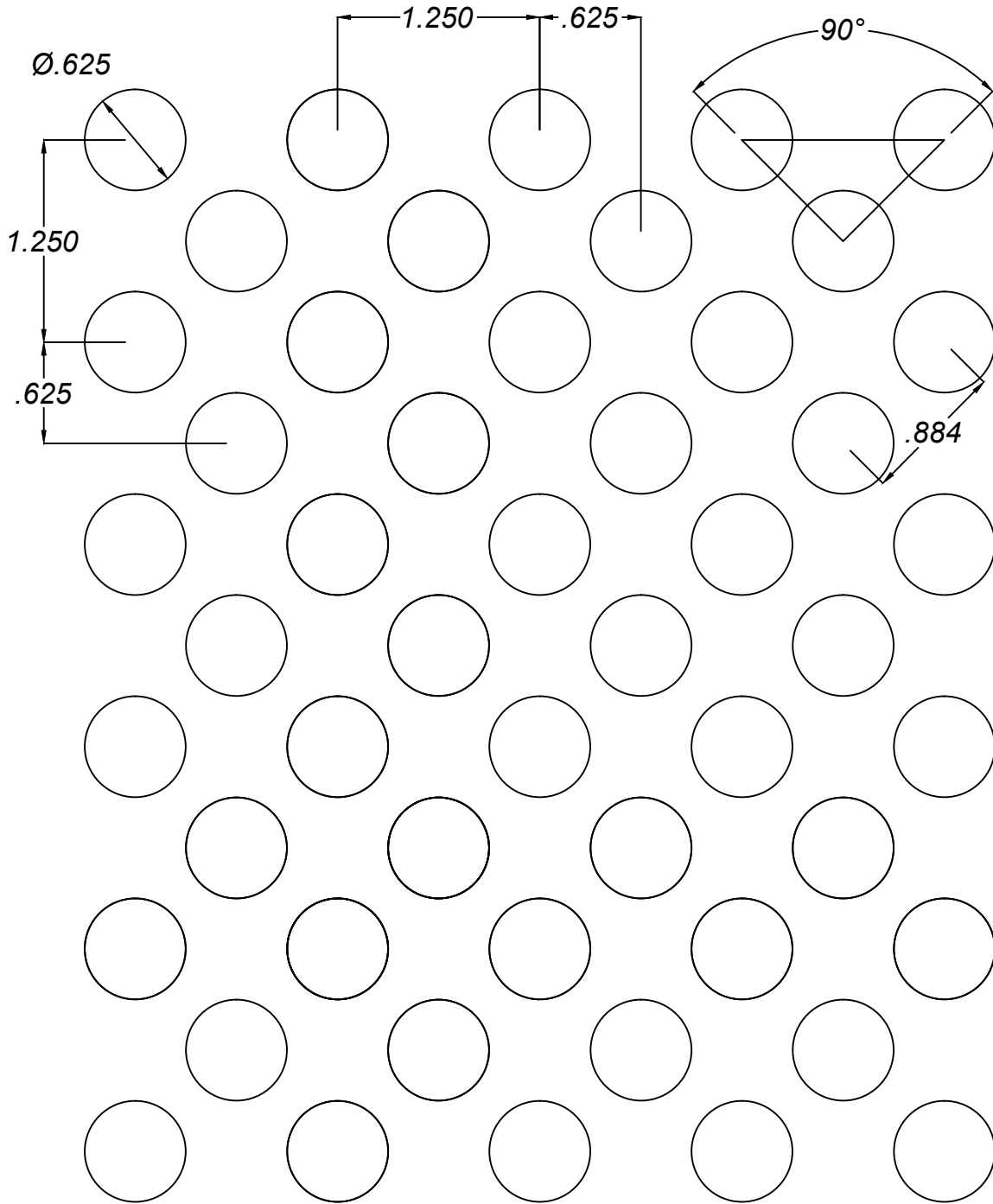

C-PERF-13

OPEN AREA 39.27%

SCALE: 1=1



2150 Boul Hymus
Dorval (QC) H9P 1J7

T: (514) 683-0179 F: (514) 683-9651

TOLERANCES :

FRACTIONS	DECIMALS	ANGLES
$\pm 1/64$	$.XX \pm 0.030$	± 0.5
	$.XXX \pm 0.015$	

UNLESS OTHERWISE SPECIFIED
DIMENSIONS ARE IN INCHES

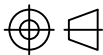

Material Finish Specifications:

XXX THICK
MATERIAL: XXXX
FINISH: XXXX
QTY: XXXX

SYSTEM XXXX

DESC.

Date: FEB-3-2016

PG
1/1

Any copy hereof issued by CARRITEC must be kept confidential and used by the recipient only for the specific purpose for which it is issued in conjunction with materials supplied or purchased and listed hereon.

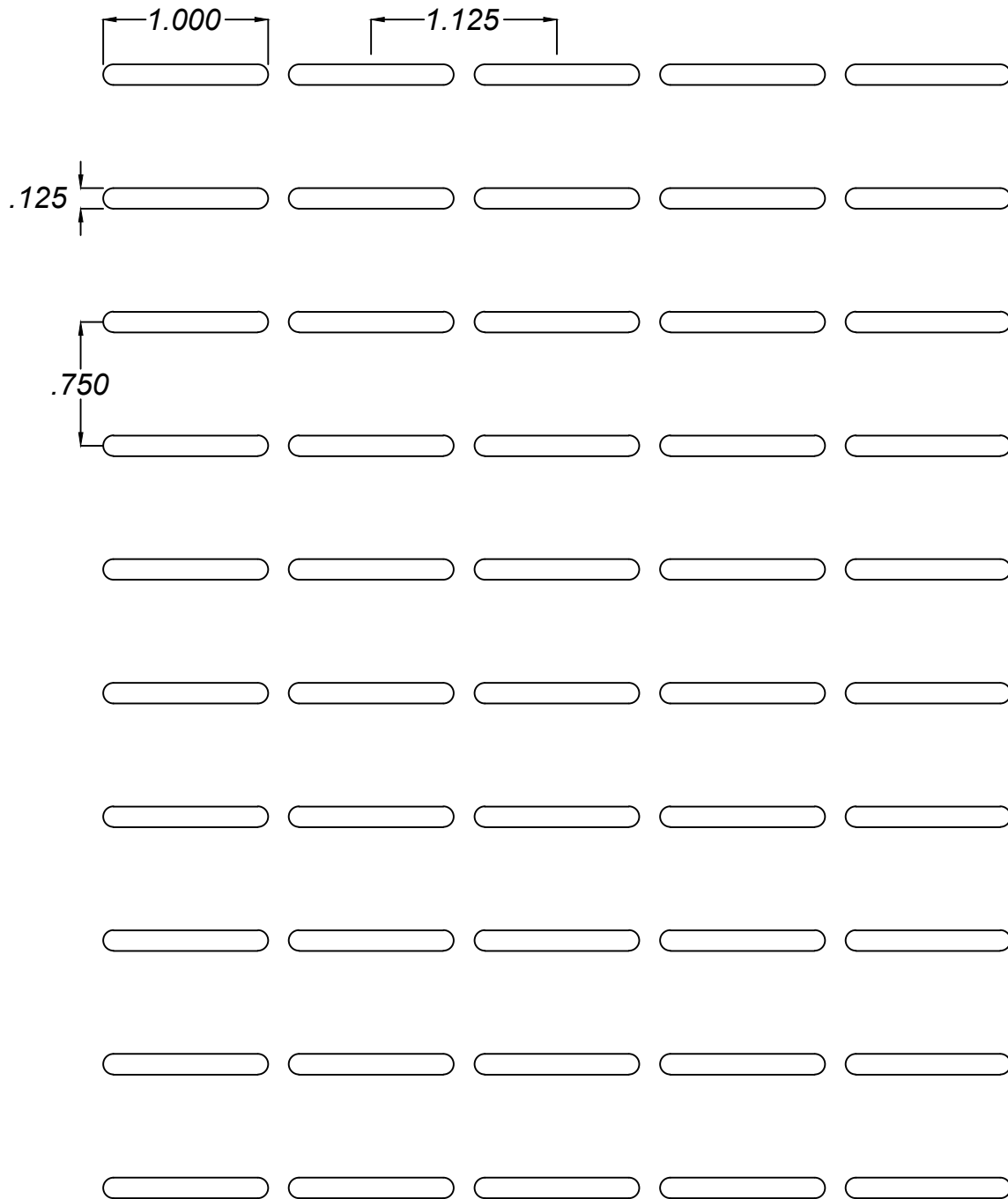

C-PERF-14

OPEN AREA 14.4%

SCALE: 1=1



2150 Boul Hymus
Dorval (QC) H9P 1J7

T: (514) 683-0179 F: (514) 683-9651

TOLERANCES :

FRACTIONS	DECIMALS	ANGLES
± 1/64	.XX 0.030	± 0.5
	.XXX ± 0.015	

UNLESS OTHERWISE SPECIFIED
DIMENSIONS ARE IN INCHES

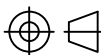

Material Finish Specifications:

XXX THICK
MATERIAL: XXXX
FINISH: XXXX
QTY: XXXX

SYSTEM XXXX

DESC.

Date: FEB-3-2016

PG
1/1

Any copy hereof issued by CARRITEC must be kept confidential and used by the recipient only for the specific purpose for which it is issued in conjunction with materials supplied or purchased and listed hereon.

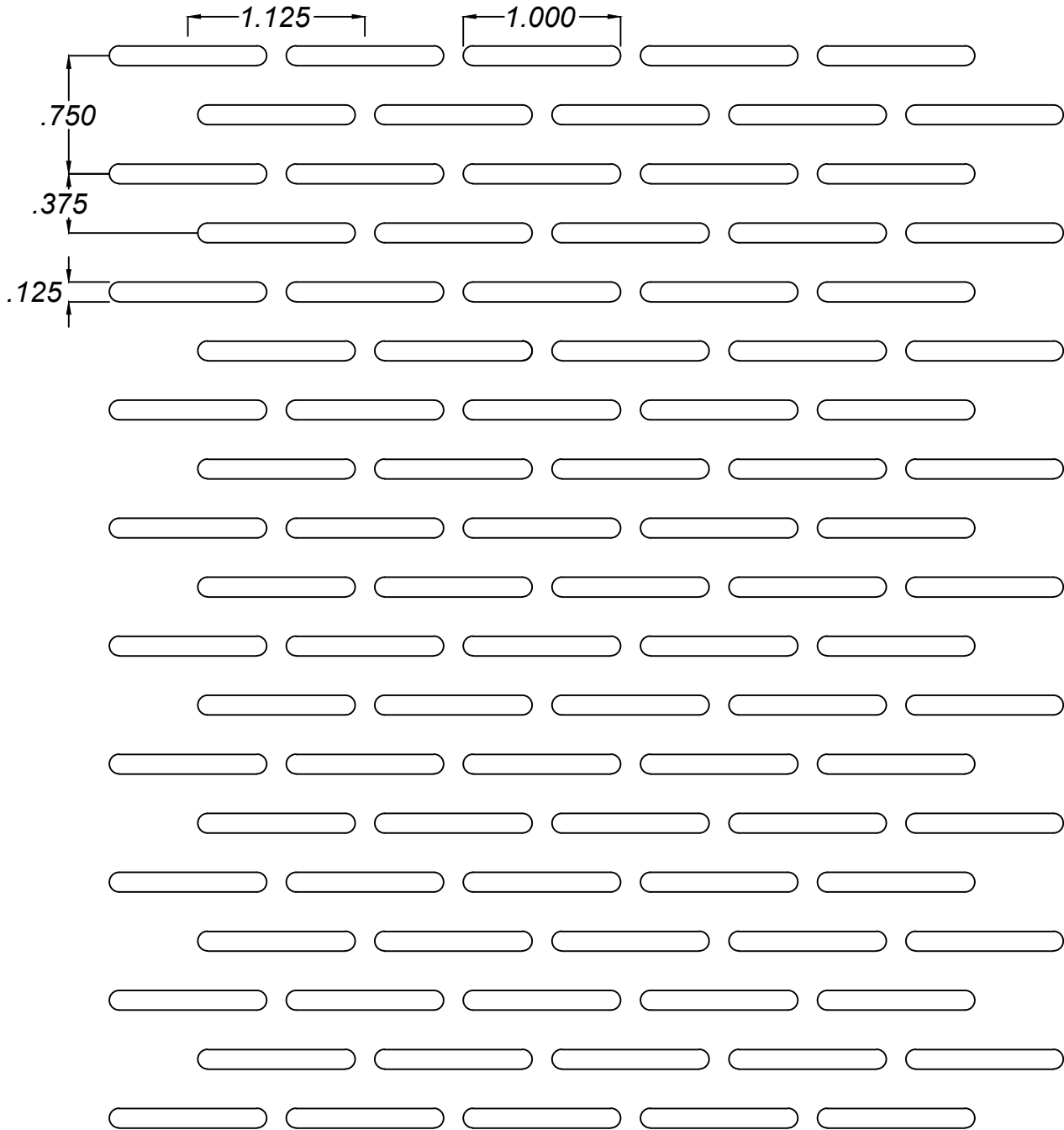

C-PERF-15

OPEN AREA 28.83%

SCALE: 1=1



2150 Boul Hymus
Dorval (QC) H9P 1J7

T: (514) 683-0179 F: (514) 683-9651

TOLERANCES :

FRACTIONS	DECIMALS	ANGLES
± 1/64	.XX ± 0.030	± 0.5
	.XXX ± 0.015	
UNLESS OTHERWISE SPECIFIED		
DIMENSIONS ARE IN INCHES		

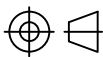

Material Finish Specifications:

XXX THICK
MATERIAL: XXXX
FINISH: XXXX
QTY: XXXX

SYSTEM XXXX

DESC.

Date: FEB-3-2016

PG
1/1

Any copy hereof issued by CARRITEC must be kept confidential and used by the recipient only for the specific purpose for which it is issued in conjunction with materials supplied or purchased and listed hereon.

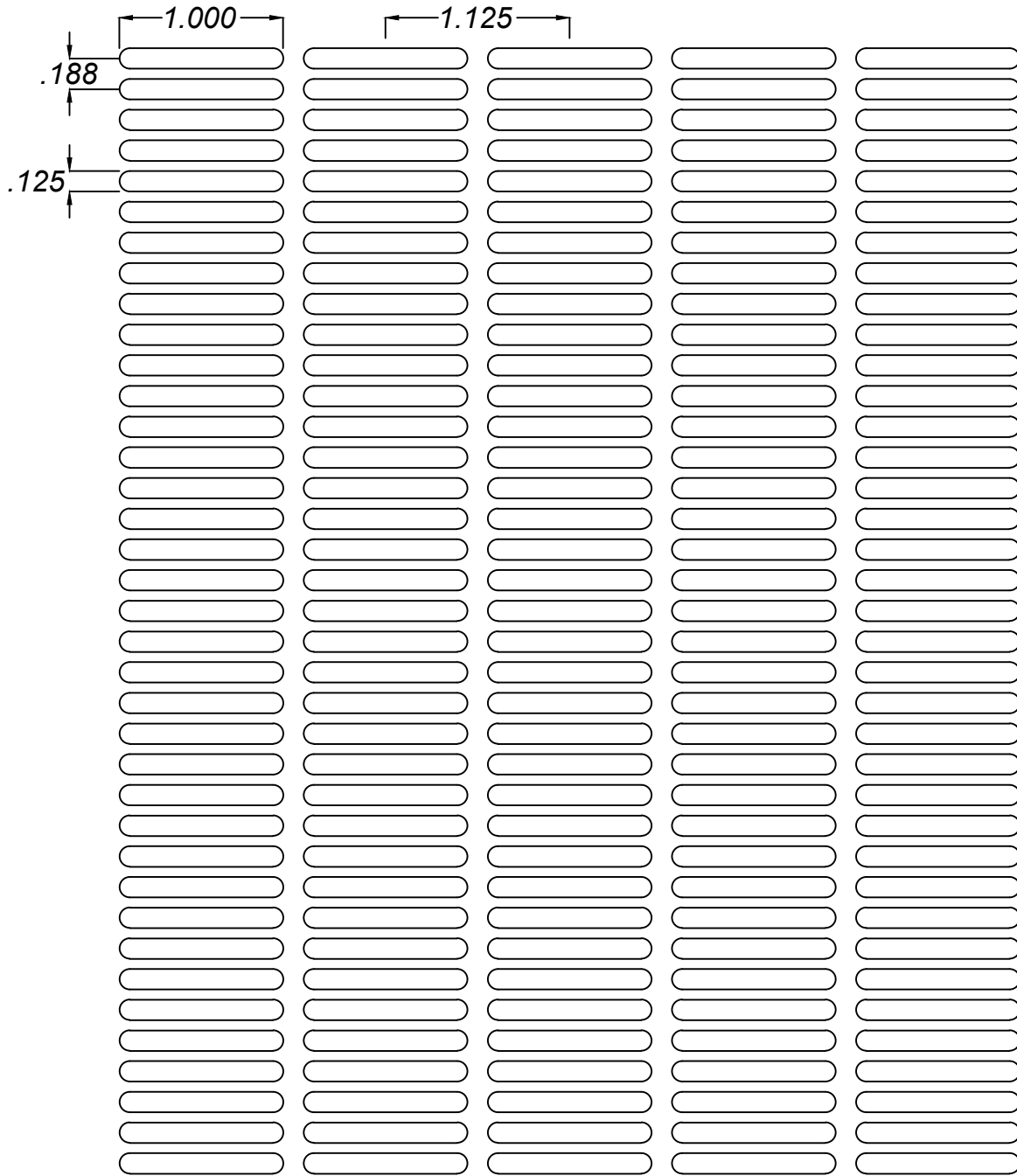

C-PERF-16

OPEN AREA 57.7%

SCALE: 1=1



2150 Boul Hymus
Dorval (QC) H9P 1J7

T: (514) 683-0179 F: (514) 683-9651

TOLERANCES :

FRACTIONS	DECIMALS	ANGLES
± 1/64	.XX 0.030	± 0.5
	.XXX ± 0.015	
UNLESS OTHERWISE SPECIFIED		
DIMENSIONS ARE IN INCHES		

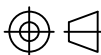

Material Finish Specifications:

XXX THICK
 MATERIAL: XXXX
 FINISH: XXXX
 QTY: XXXX

SYSTEM XXXX

DESC.

Date: FEB-3-2016

PG
1/1

Any copy hereof issued by CARRITEC must be kept confidential and used by the recipient only for the specific purpose for which it is issued in conjunction with materials supplied or purchased and listed hereon.

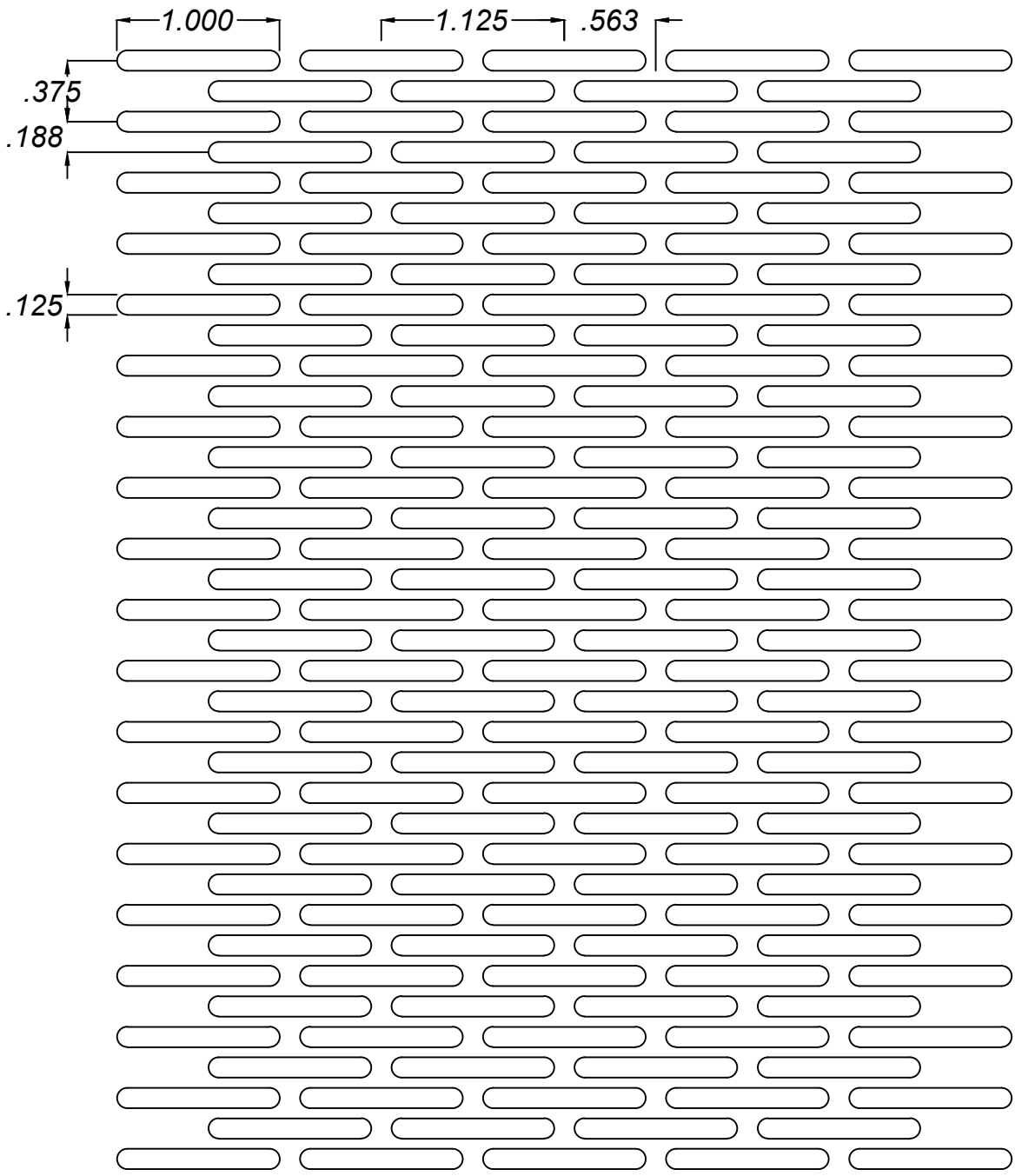

C-PERF-17
 OPEN AREA 57.51%

SCALE: 1=1

CARRITEC
 Architectural Products
 2150 Boul Hymus
 Dorval (QC) H9P 1J7
 T: (514) 683-0179 F: (514) 683-9651

TOLERANCES :

FRACTIONS ± 1/64	DECIMALS .XX ± 0.030 .XXX ± 0.015	ANGLES ± 0.5
---------------------	---	-----------------

UNLESS OTHERWISE SPECIFIED
 DIMENSIONS ARE IN INCHES

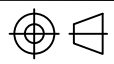

Material Finish Specifications:
 XXX THICK
 MATERIAL: XXXX
 FINISH: XXXX
 QTY: XXXX

SYSTEM	XXXX
DESC.	
Date:	FEB-3-2016
PG	1/1

Any copy hereof issued by CARRITEC must be kept confidential and used by the recipient only for the specific purpose for which it is issued in conjunction with materials supplied or purchased and listed hereon.

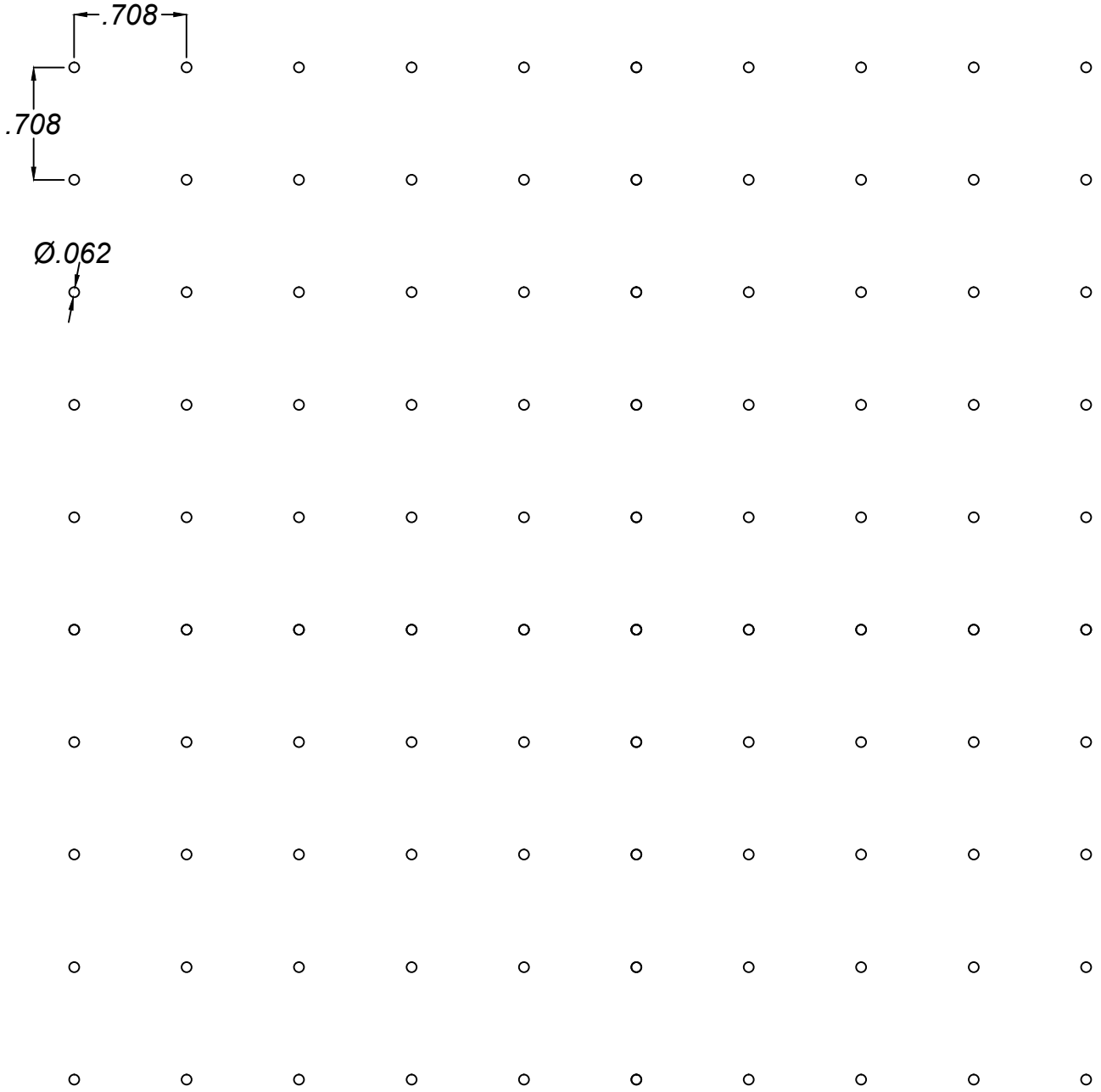

C-PERF-18

OPEN AREA 0.60%

SCALE: 1=1



CARRITEC
Architectural Products

2150 Boul Hymus
Dorval (QC) H9P 1J7
T: (514) 683-0179 F: (514) 683-9651

TOLERANCES :

FRACTIONS	DECIMALS	ANGLES
±1/64	.XX 0.030	±0.5
	.XXX ±0.015	

UNLESS OTHERWISE SPECIFIED
DIMENSIONS ARE IN INCHES

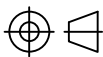

Material Finish Specifications:

XXX THICK
MATERIAL: XXXX
FINISH: XXXX
QTY: XXXX

SYSTEM XXXX

DESC.

Date: FEB-3-2016

PG
1/1

Any copy hereof issued by CARRITEC must be kept confidential and used by the recipient only for the specific purpose for which it is issued in conjunction with materials supplied or purchased and listed hereon.

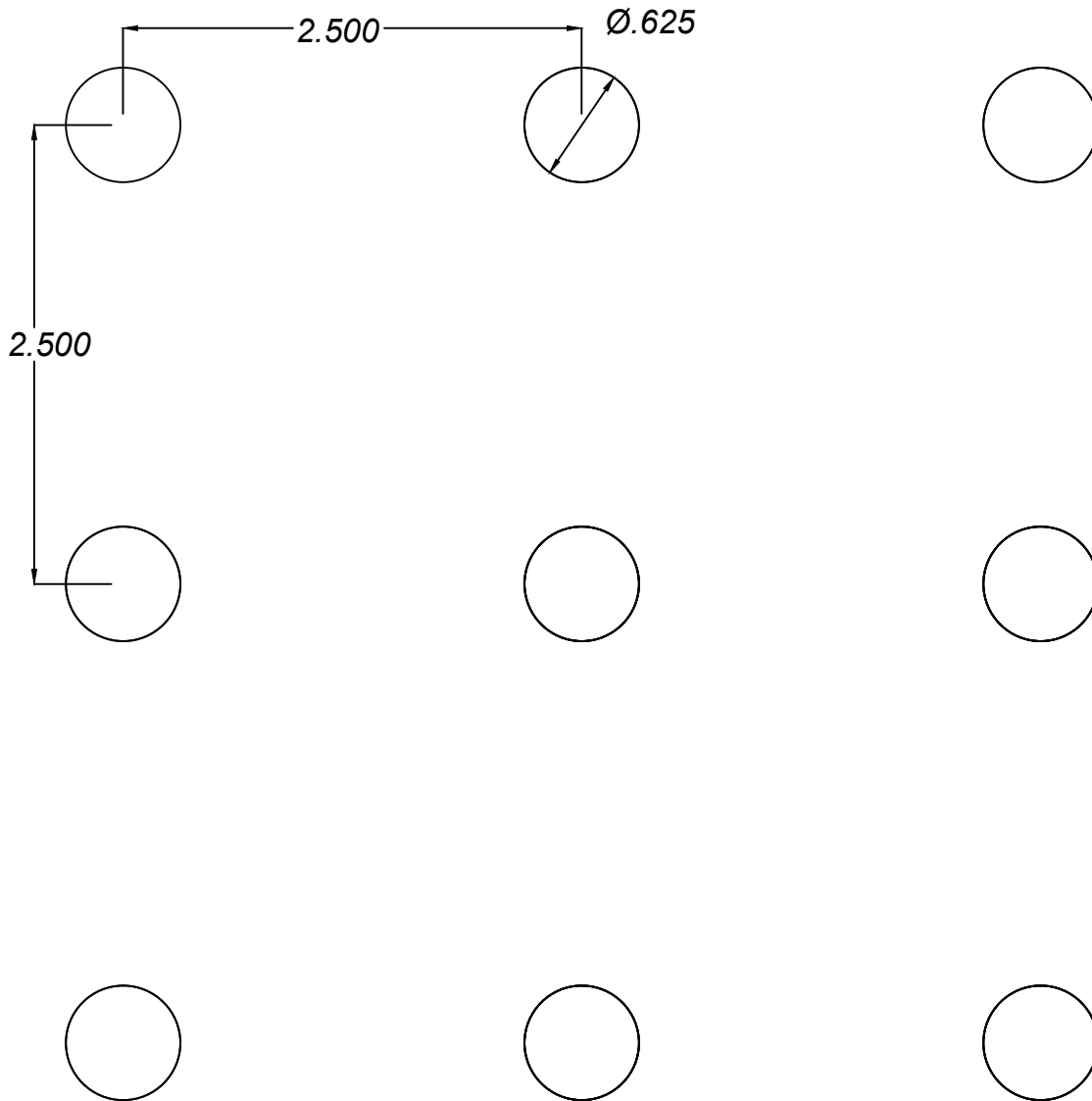

C-PERF-19
 OPEN AREA 4.9%

SCALE: 1=1



2150 Boul Hymus
 Dorval (QC) H9P 1J7

T: (514) 683-0179 F: (514) 683-9651

TOLERANCES :

FRACTIONS	DECIMALS	ANGLES
±1/64	.XX ±0.030	±0.5
	.XXX ±0.015	

UNLESS OTHERWISE SPECIFIED
 DIMENSIONS ARE IN INCHES

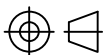

Material Finish Specifications:

XXX THICK
 MATERIAL: XXXX
 FINISH: XXXX
 QTY: XXXX

SYSTEM XXXX

DESC.

Date: FEB-3-2016

PG
 1/1

Any copy hereof issued by CARRITEC must be kept confidential and used by the recipient only for the specific purpose for which it is issued in conjunction with materials supplied or purchased and listed hereon.

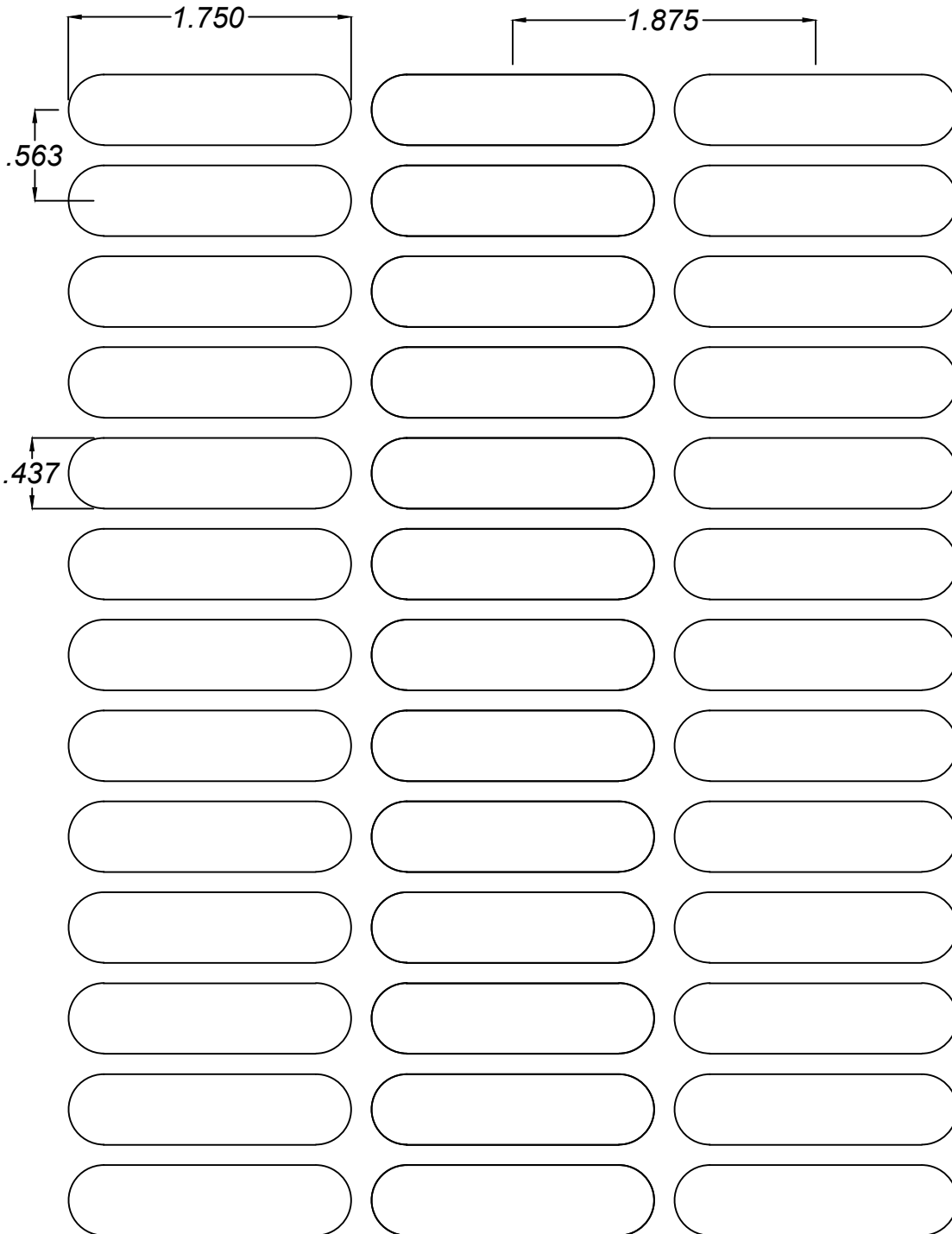

C-PERF-20

OPEN AREA 68.56%

SCALE: 1=1



2150 Boul Hymus
Dorval (QC) H9P 1J7

T: (514) 683-0179 F: (514) 683-9651

TOLERANCES :

FRACTIONS	DECIMALS	ANGLES
± 1/64	.XX 0.030	± 0.5
	.XXX ± 0.015	
UNLESS OTHERWISE SPECIFIED		
DIMENSIONS ARE IN INCHES		

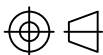

Material Finish Specifications:

XXX THICK
MATERIAL: XXXX
FINISH: XXXX
QTY: XXXX

SYSTEM XXXX

DESC.

Date: FEB-3-2016

PG
1/1

Any copy hereof issued by CARRITEC must be kept confidential and used by the recipient only for the specific purpose for which it is issued in conjunction with materials supplied or purchased and listed hereon.

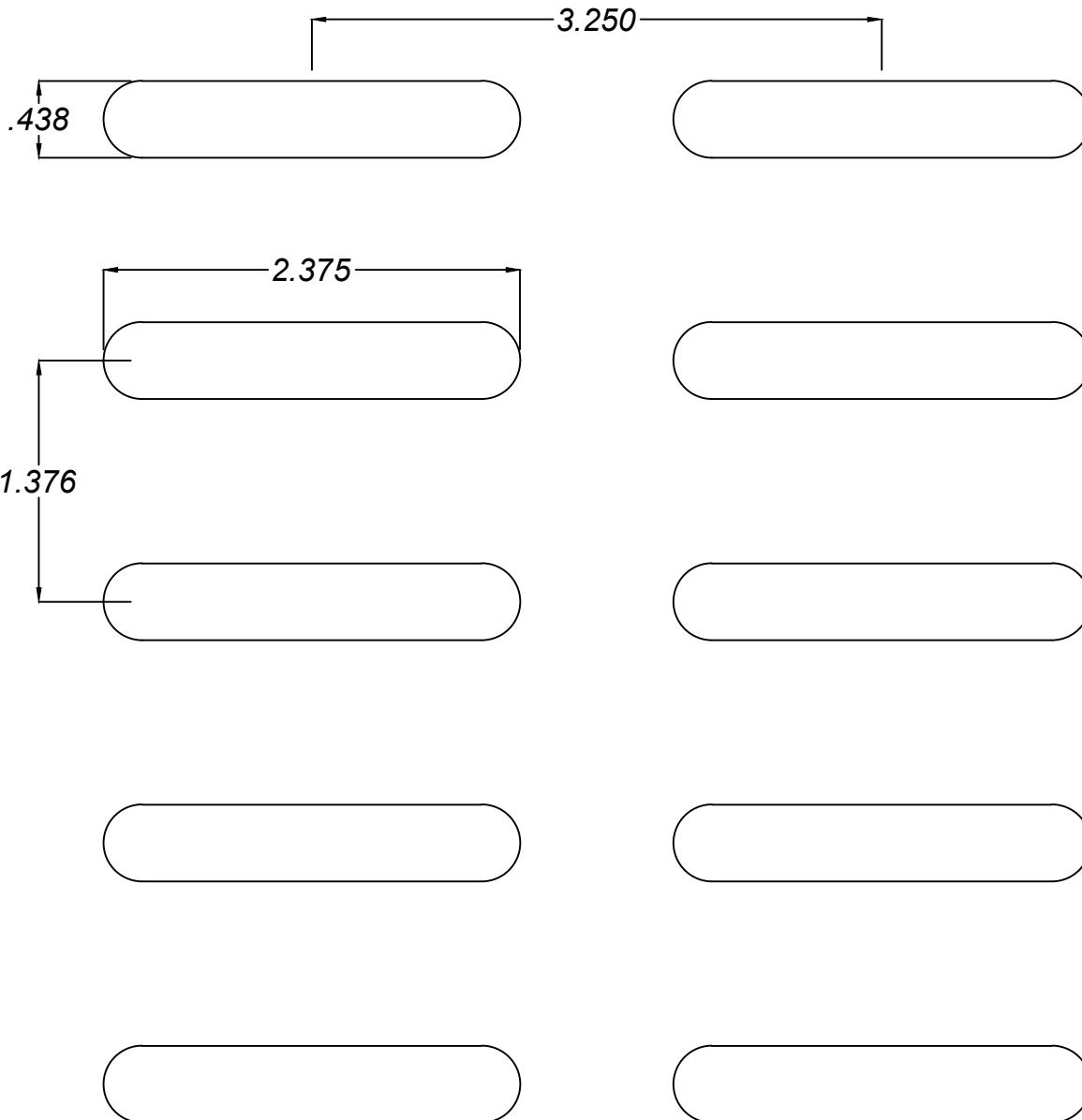

C-PERF-21

OPEN AREA 22.34%

SCALE: 1=1



2150 Boul Hymus
Dorval (QC) H9P 1J7

T: (514) 683-0179 F: (514) 683-9651

TOLERANCES :

FRACTIONS	DECIMALS	ANGLES
± 1/64	.XX ± 0.030	± 0.5
	.XXX ± 0.015	
UNLESS OTHERWISE SPECIFIED		
DIMENSIONS ARE IN INCHES		



Material Finish Specifications:

XXX THICK
MATERIAL: XXXX
FINISH: XXXX
QTY: XXXX

SYSTEM XXXX

DESC.

Date: FEB-3-2016

PG
1/1

Any copy hereof issued by CARRITEC must be kept confidential and used by the recipient only for the specific purpose for which it is issued in conjunction with materials supplied or purchased and listed hereon.

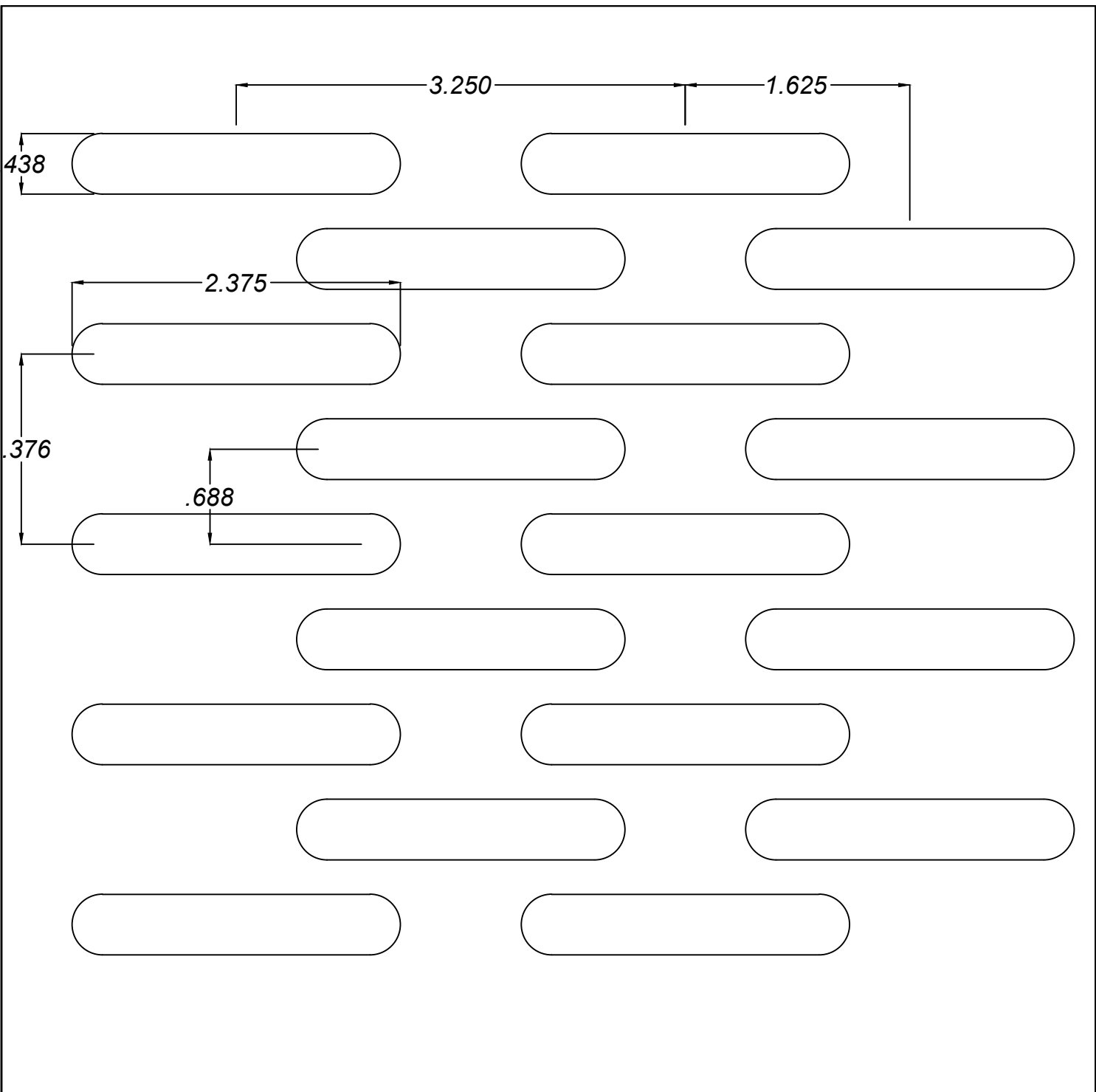

C-PERF-22

OPEN AREA 44.69%

SCALE: 1=1

<p>2150 Boul Hymus Dorval (QC) H9P 1J7 T: (514) 683-0179 F: (514) 683-9651</p>	<p>TOLERANCES :</p> <table border="0"> <tr> <td>FRACTIONS</td> <td>DECIMALS</td> <td>ANGLES</td> </tr> <tr> <td>± 1/64</td> <td>.XX 0.030</td> <td>± 0.5</td> </tr> <tr> <td colspan="3">.XXX ± 0.015</td> </tr> </table> <p>UNLESS OTHERWISE SPECIFIED DIMENSIONS ARE IN INCHES</p>	FRACTIONS	DECIMALS	ANGLES	± 1/64	.XX 0.030	± 0.5	.XXX ± 0.015			<p>Material Finish Specifications:</p> <p>XXX THICK MATERIAL: XXXX FINISH: XXXX QTY: XXXX</p>	SYSTEM XXXX
		FRACTIONS	DECIMALS	ANGLES								
± 1/64	.XX 0.030	± 0.5										
.XXX ± 0.015												
DESC.	Date: FEB-3-2016	PG 1/1										

Any copy hereof issued by CARRITEC must be kept confidential and used by the recipient only for the specific purpose for which it is issued in conjunction with materials supplied or purchased and listed hereon.

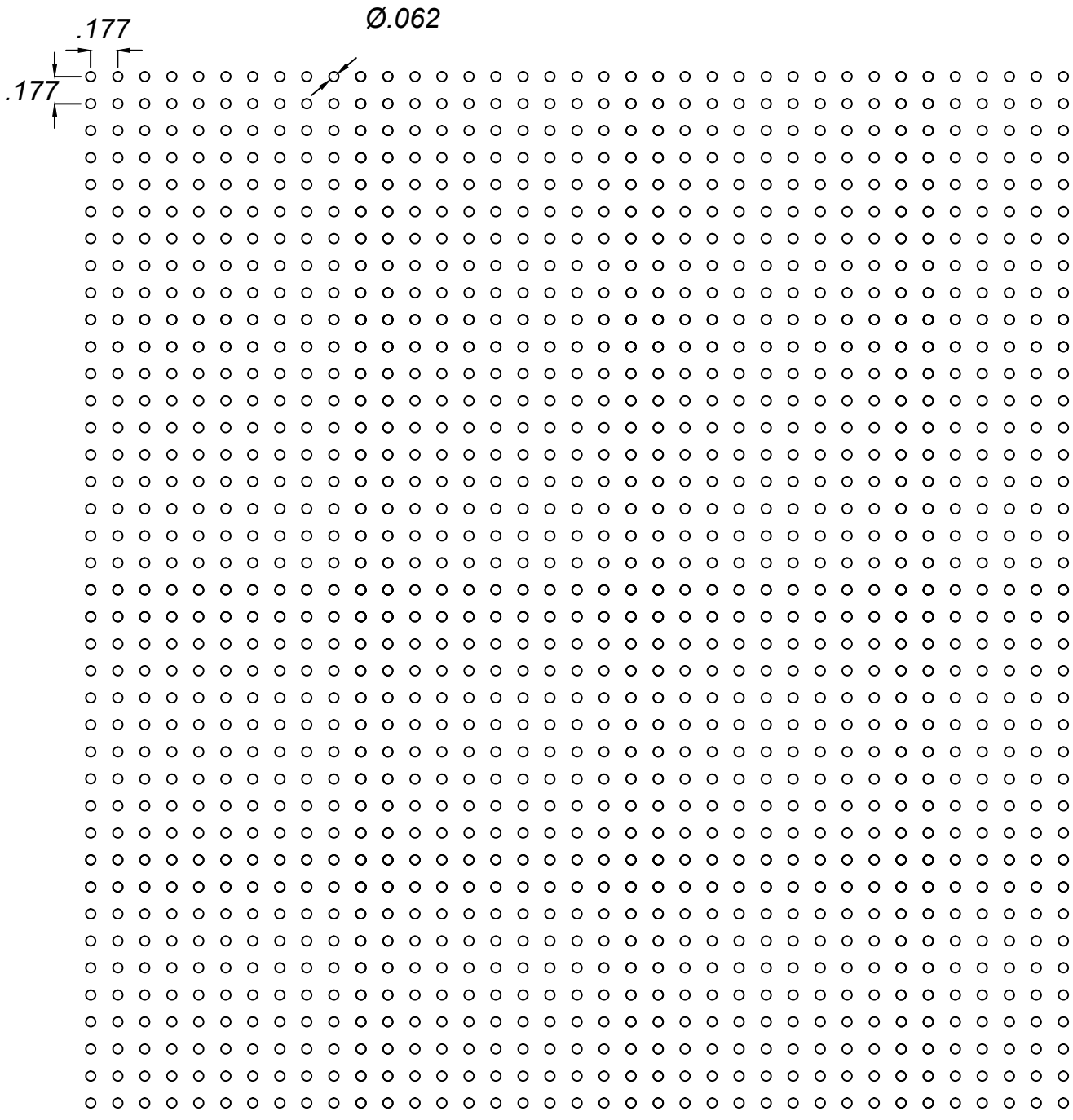

C-PERF-23

OPEN AREA 9.03%

SCALE: 1=1

2150 Boul Hymus
Dorval (QC) H9P 1J7
T: (514) 683-0179 F: (514) 683-9651

TOLERANCES :

FRACTIONS	DECIMALS	ANGLES
± 1/64	.XX 0.030	± 0.5
	.XXX ± 0.015	

UNLESS OTHERWISE SPECIFIED
DIMENSIONS ARE IN INCHES

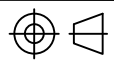

Material Finish Specifications:
 XXX THICK
 MATERIAL: XXXX
 FINISH: XXXX
 QTY: XXXX

SYSTEM	XXXX
DESC.	
Date:	FEB-3-2016

Any copy hereof issued by CARRITEC must be kept confidential and used by the recipient only for the specific purpose for which it is issued in conjunction with materials supplied or purchased and listed hereon.

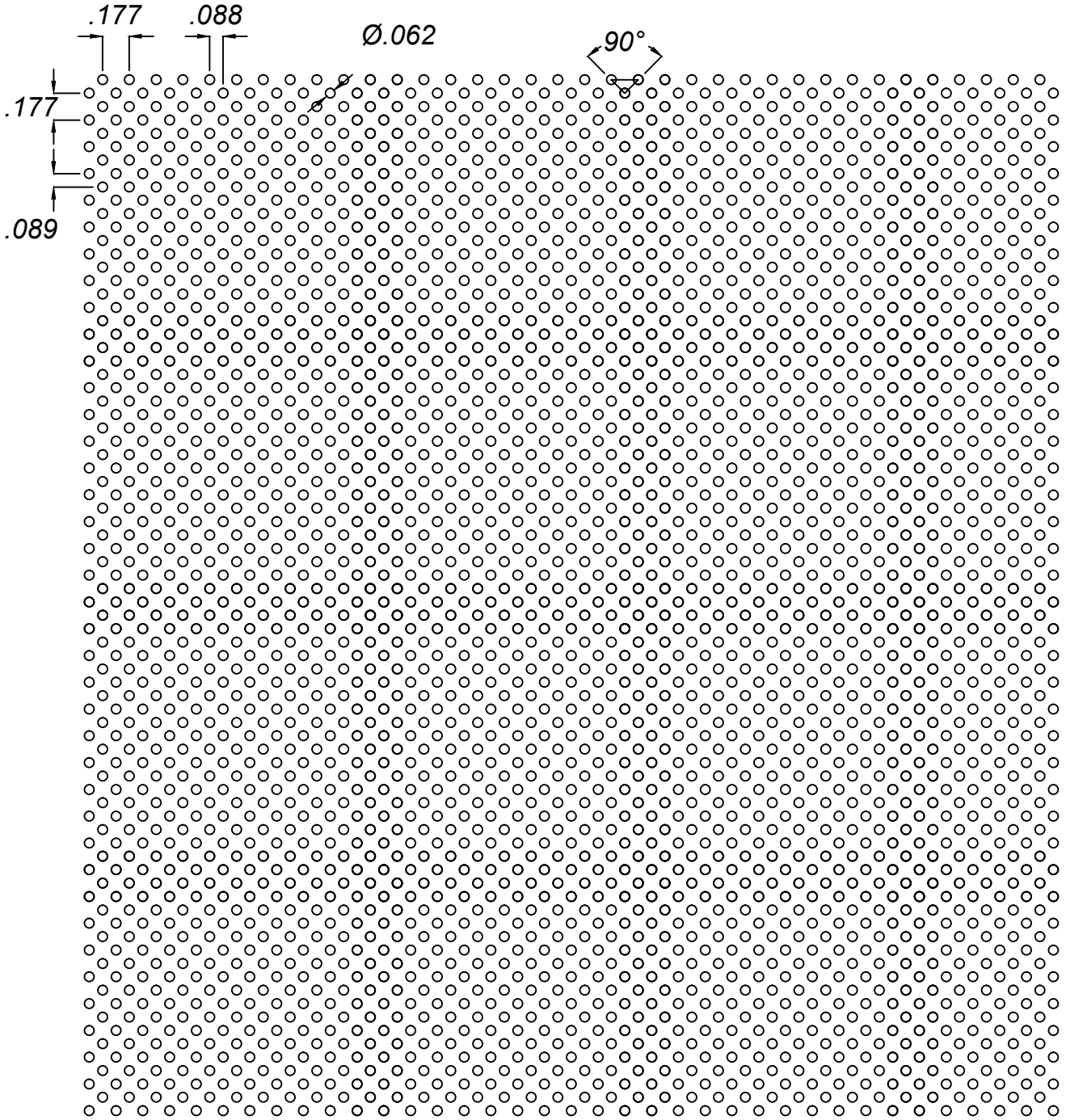

C-PERF-24

OPEN AREA 19.3%

SCALE: 1=1



2150 Boul Hymus
Dorval (QC) H9P 1J7
T: (514) 683-0179 F: (514) 683-9651

TOLERANCES :

FRACTIONS	DECIMALS	ANGLES
± 1/64	.XX 0.030	± 0.5
	.XXX ± 0.015	
UNLESS OTHERWISE SPECIFIED		
DIMENSIONS ARE IN INCHES		

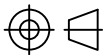

Material Finish Specifications:

XXX THICK
MATERIAL: XXXX
FINISH: XXXX
QTY: XXXX

SYSTEM XXXX

DESC.

Date: FEB-3-2016

PG
1/1

Any copy hereof issued by CARRITEC must be kept confidential and used by the recipient only for the specific purpose for which it is issued in conjunction with materials supplied or purchased and listed hereon.

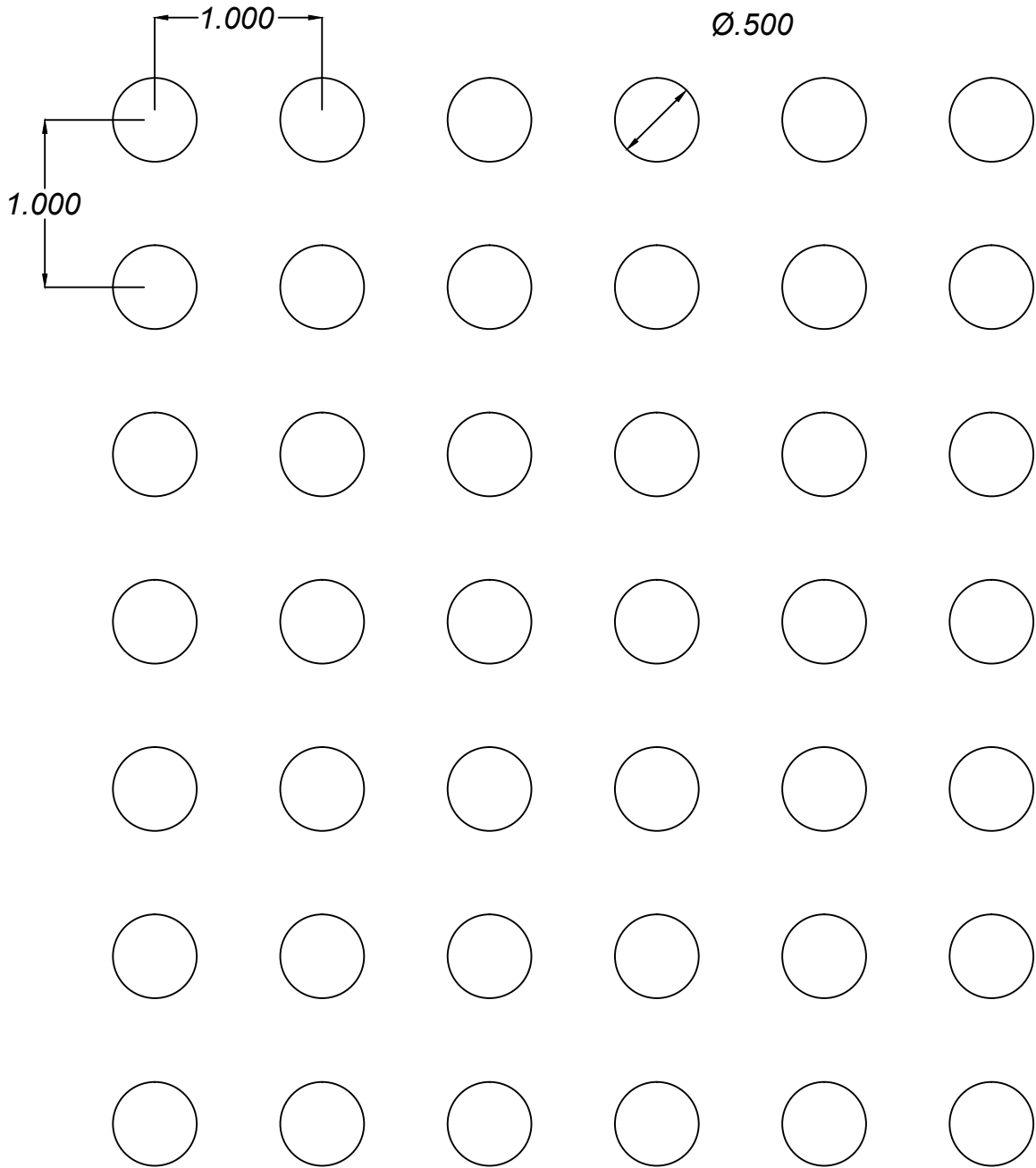

C-PERF-25

OPEN AREA 19.6%

SCALE: 1=1



2150 Boul Hymus
Dorval (QC) H9P 1J7

T: (514) 683-0179 F: (514) 683-9651

TOLERANCES :

FRACTIONS	DECIMALS	ANGLES
± 1/64	.XX ± 0.030	± 0.5
	.XXX ± 0.015	

UNLESS OTHERWISE SPECIFIED
DIMENSIONS ARE IN INCHES

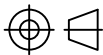

Material Finish Specifications:

XXX THICK
MATERIAL: XXXX
FINISH: XXXX
QTY: XXXX

SYSTEM XXXX

DESC.

Date: FEB-3-2016

PG
1/1

Any copy hereof issued by CARRITEC must be kept confidential and used by the recipient only for the specific purpose for which it is issued in conjunction with materials supplied or purchased and listed hereon.

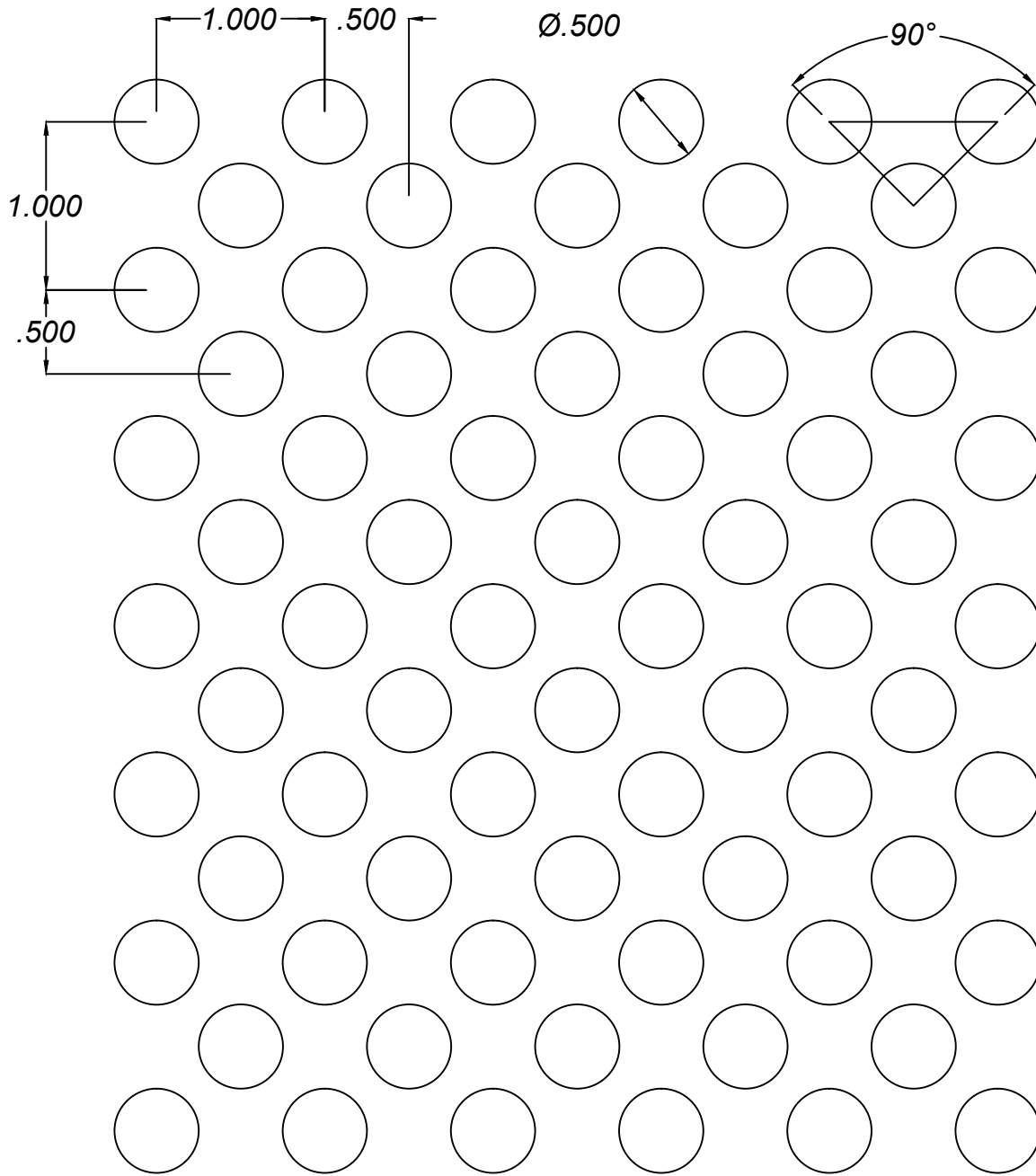

C-PERF-26

OPEN AREA 39.3%

SCALE: 1=1



2150 Boul Hymus
Dorval (QC) H9P 1J7
T: (514) 683-0179 F: (514) 683-9651

TOLERANCES :

FRACTIONS	DECIMALS	ANGLES
± 1/64	.XX 0.030	± 0.5
	.XXX ± 0.015	

UNLESS OTHERWISE SPECIFIED
DIMENSIONS ARE IN INCHES

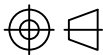

Material Finish Specifications:

XXX THICK
MATERIAL: XXXX
FINISH: XXXX
QTY: XXXX

SYSTEM XXXX

DESC.

Date: FEB-3-2016

PG 1/1

Any copy hereof issued by CARRITEC must be kept confidential and used by the recipient only for the specific purpose for which it is issued in conjunction with materials supplied or purchased and listed hereon.

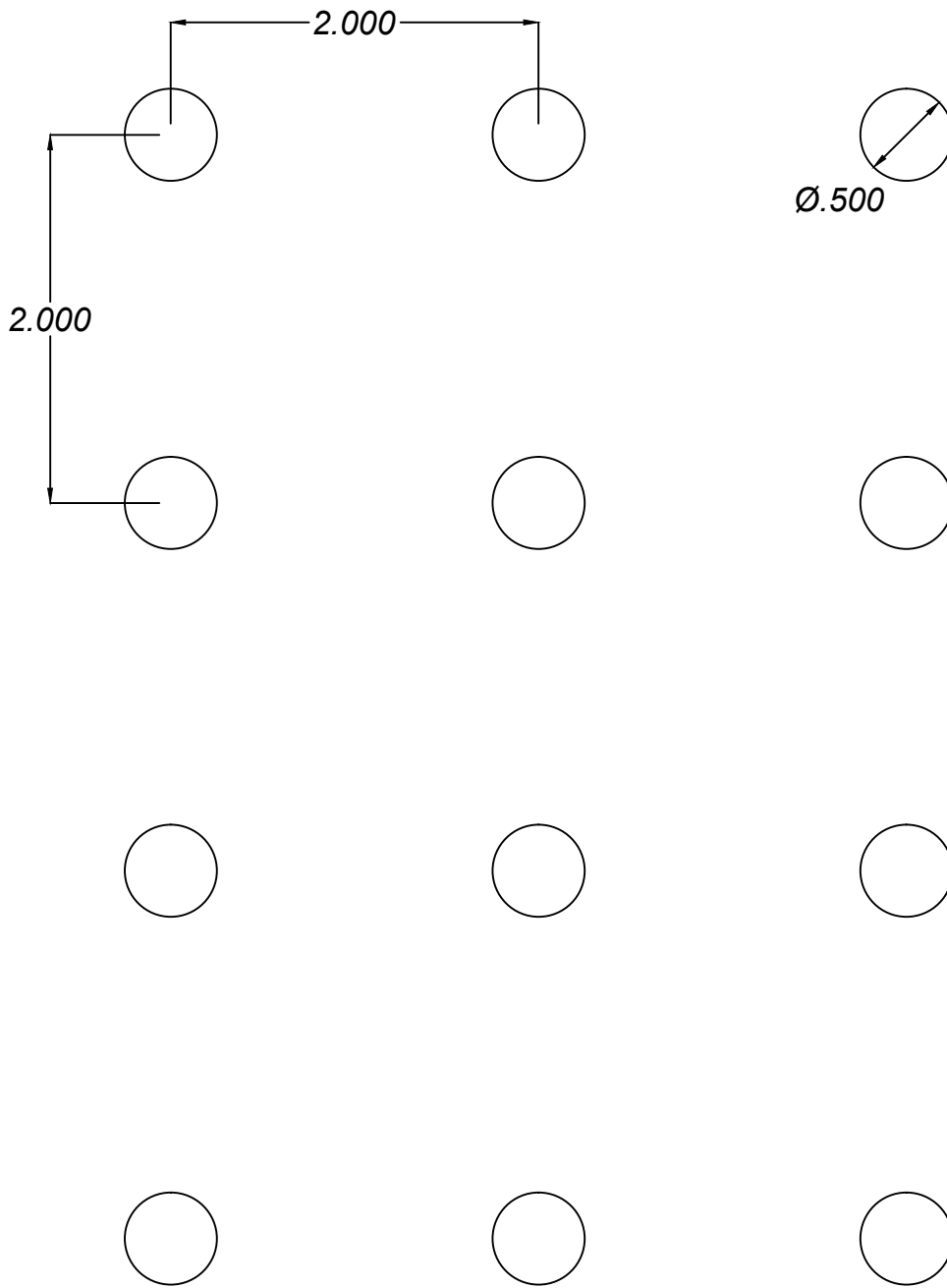

C-PERF-27

OPEN AREA 4.9%

SCALE: 1=1



2150 Boul Hymus
Dorval (QC) H9P 1J7

T: (514) 683-0179 F: (514) 683-9651

TOLERANCES :

FRACTIONS	DECIMALS	ANGLES
± 1/64	.XX ± 0.030	± 0.5
	.XXX ± 0.015	

UNLESS OTHERWISE SPECIFIED
DIMENSIONS ARE IN INCHES

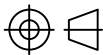

Material Finish Specifications:

XXX THICK
MATERIAL: XXXX
FINISH: XXXX
QTY: XXXX

SYSTEM XXXX

DESC.

Date: FEB-3-2016

PG
1/1

Any copy hereof issued by CARRITEC must be kept confidential and used by the recipient only for the specific purpose for which it is issued in conjunction with materials supplied or purchased and listed hereon.

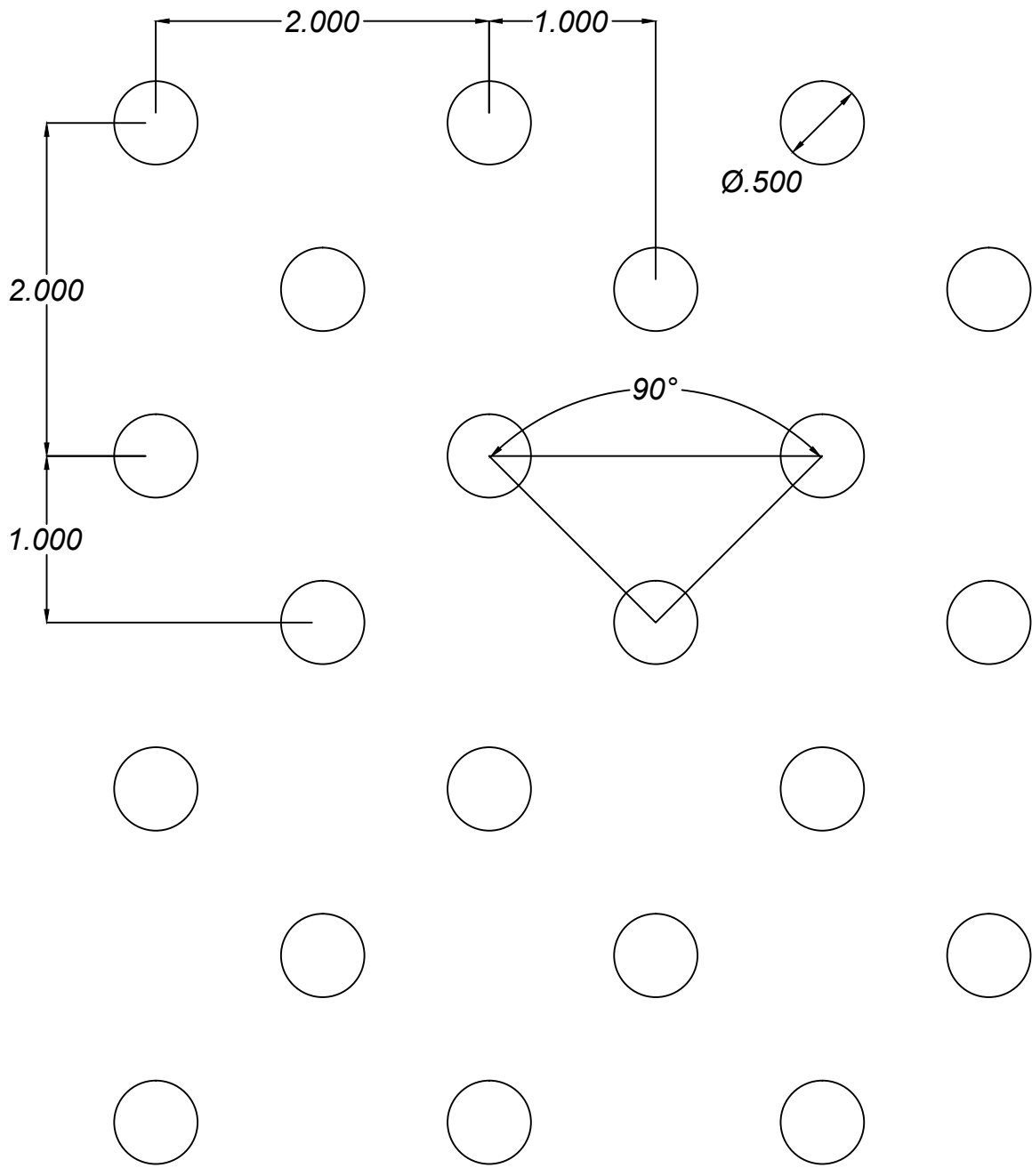

C-PERF-28
 OPEN AREA 9.8%

SCALE: 1=1



2150 Boul Hymus
 Dorval (QC) H9P 1J7
 T: (514) 683-0179 F: (514) 683-9651

TOLERANCES :

FRACTIONS	DECIMALS	ANGLES
± 1/64	.XX 0.030	± 0.5
	.XXX ± 0.015	

UNLESS OTHERWISE SPECIFIED
 DIMENSIONS ARE IN INCHES

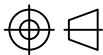

Material Finish Specifications:

XXX THICK
 MATERIAL: XXXX
 FINISH: XXXX
 QTY: XXXX

SYSTEM XXXX

DESC.

Date: FEB-3-2016

PG
 1/1

Any copy hereof issued by CARRITEC must be kept confidential and used by the recipient only for the specific purpose for which it is issued in conjunction with materials supplied or purchased and listed hereon.

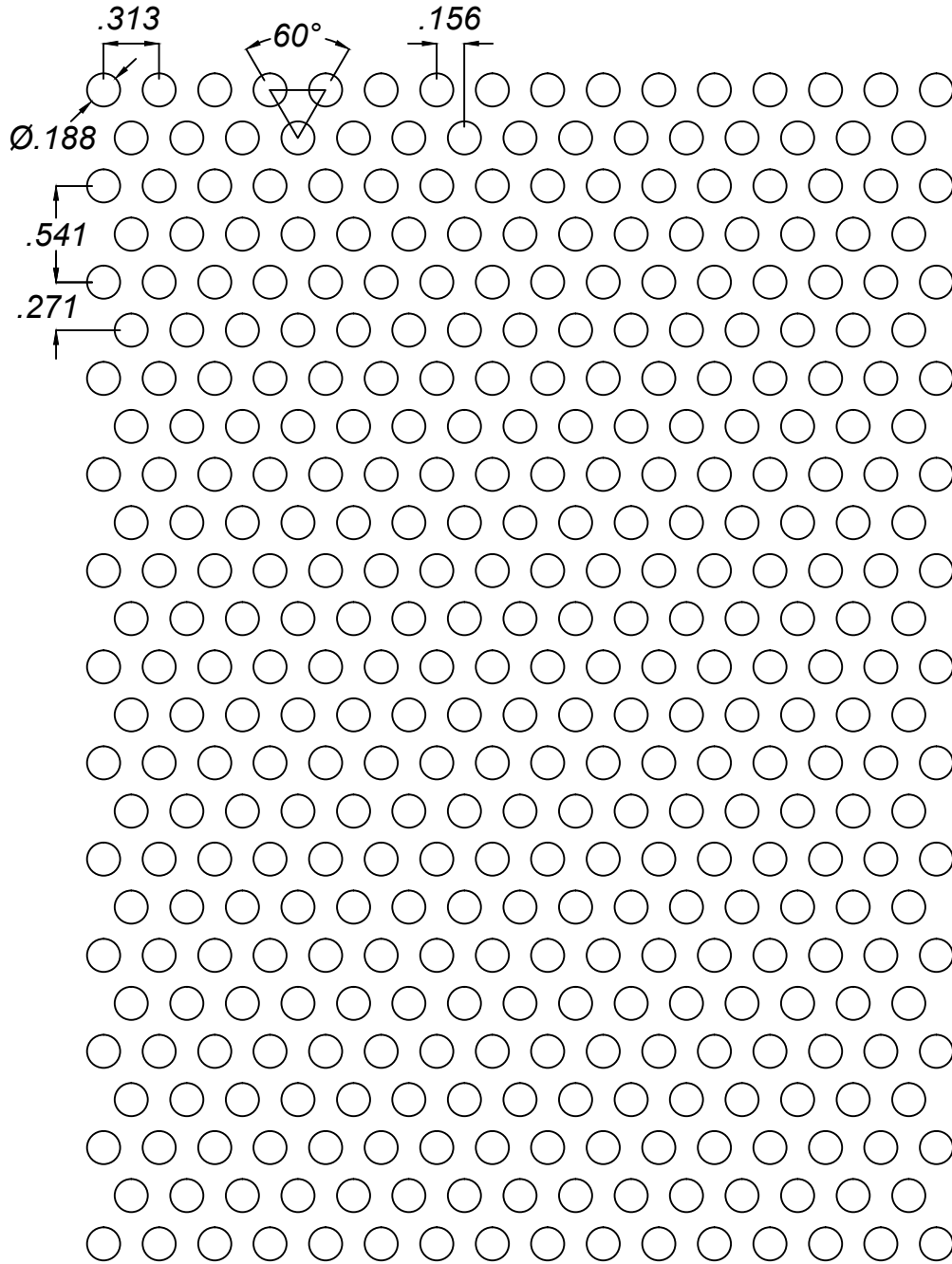

C-PERF-29

OPEN AREA 32.6%

SCALE: 1=1



2150 Boul Hymus
Dorval (QC) H9P 1J7

T: (514) 683-0179 F: (514) 683-9651

TOLERANCES :

FRACTIONS	DECIMALS	ANGLES
± 1/64	.XX 0.030	± 0.5
	.XXX ± 0.015	

UNLESS OTHERWISE SPECIFIED
DIMENSIONS ARE IN INCHES

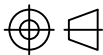

Material Finish Specifications:

XXX THICK
MATERIAL: XXXX
FINISH: XXXX
QTY: XXXX

SYSTEM XXXX

DESC.

Date: FEB-3-2016

PG
1/1

Any copy hereof issued by CARRITEC must be kept confidential and used by the recipient only for the specific purpose for which it is issued in conjunction with materials supplied or purchased and listed hereon.